

User Guide

Version 1.6.9



Safety and Compliance	6
User Guide Versions	7
Product Information	8
Canada and the USA	8
Europe	8
Rest of the World	8
What's in the box?	10
Charge your T-RX™ internal battery	10
Connector Dust Covers	10
How does it work?	11
How to set up?	11
How do I connect the external antenna?	11
How do I adjust the screen brightness?	12
How do I calibrate the T-RX™ touchscreen?	12
How do I change the T-RX™ touchscreen to High Contrast Mode?	14
How do I connect to an Ethernet network?	15
How do I connect to a Wi-Fi network?	16
How do I configure an Access Point network?	17
About System Page	18
Check for upgrade	18
About Support Page	19
How do I change the battery?	21
Getting Technical	22
Connector Info	22
ARINC 429 Connector Pinout	23
ARINC-429 Mating Connector	24
LED Indicators	25
Test Details	25

User Input	26
Antenna/Port Selection	27
Antenna Use	28
VOR Test	29
ILS Test	30
Localizer Test	31
Glideslope Test	32
Marker Beacon Test	33
VHF Com Generate Test	34
VHF Com Receive Test	35
Receive Audio	36
ELT 121.5 Testing	36
HF Com Generate Test	37
HF Com Receive Test	38
Receive Audio	39
SELCAL Test	40
ELT 406 Test	41
ELT 406 Test Config	42
DME Test	43
DME Test Config	44
TCAS Test	45
TCAS Test Config	46
Transponder Mode A/C/S Test	47
Transponder Test Config	48
Transponder Mode A/C/S Test Item Descriptions	49
Altitude Monitor Test	51
ADS-B OUT 1090ES Test	52
Airborne Mode	52

Surface Mode	53
ADS-B OUT 1090 Test Config	54
ADS-B 978 UAT Test	56
ADS-B 978 Test Config	57
ADS-B 1090ES / ADS-B 978 UAT Test Item Descriptions	58
ADS-B IN 1090 Test	60
ADS-B IN 1090 Test Config	61
MODE-S GICB Test	62
MODE-S GICB Test Config	64
ARINC 429 Test	65
RX Filtered	65
RX All	66
RX Raw	67
TX AHRS DIR	68
TX AHRS ACCEL	69
TX ADC/RADALT	70
Test Config	71
GPS Generator	72
GPS Test Config	73
GPS/SBAS Satellite Displayed Data	74
GPS Generator Usage	74
GPS Generator Notes	75
Test Reports	76
Test Report - Software 1.6.x and later	76
View Report	77
Remote Control and Reports	78
Sample Test Report	81
T-RX Hardware Specifications	82

T-RX RF Specifications	83
Regulatory Compliance	84
GPS Module Hardware Specifications	85
GPS Module RF Specifications	85
Troubleshooting	86
How do I connect to Remote Support?	87
License Code Activation Process	88
FAQ	89
Contact Us	90

Safety and Compliance

 This symbol refers to CAUTION items in the manual.

 This symbol indicates DC Power input requirements.

RF - Maximum T-RX and GPS Module RF output is less than 1 mW (0 dBm).

User Guide Versions

Version	Description
1.6.9	Changed A429 pin nomenclature. Expanded regulatory testing compliance section Added transponder Class A or B selection Added power input limits for RF ports Software Version 1.6.9
1.6.8	Updated for separate transponder Mode A and C MTL display and MTL difference. Added note regarding simultaneous use of GPS Generator and XPNDR test. Software Version 1.6.8
1.6.7a	Clarified ILS signal range
1.6.7	GPS SBAS range enabled. Option to enable/disable SBAS satellite. Description of SBAS automatic deselection. Added procedures for remote control of functions. Software Version 1.6.7
1.6.6	Frequency offset for Nav/Com added. VHF COM tone freq and mod level added. RF level uV values added. Transponder and ADS-B Country data added. Mode-S RI, FS, Max Airspeed, Time Sync, UF16 reply, SIL Supplement value added. Added note regarding optional dust covers. Software Version 1.6.6
1.6.1	Minor content changes, add Safety page and T-RX Controls section of T-RX Software Version 1.6.5
1.6	Incorporates tests and features of T-RX Software Version 1.5.x/1.6.x
1.5	Incorporates tests and features of T-RX Software Version 1.4.3
1.4	Incorporates tests and features of T-RX Software Versions 1.4.1 and 1.4.2
1.3	Incorporates tests and features of T-RX Software Version 1.3.4
1.2	Incorporates tests and features of T-RX Software Version 1.3.3
1.1	Incorporates tests and features of T-RX Software Version 1.3.2
1.0	Initial Release

Product Information

T-RX™ is a rugged portable tablet with a large color sunlight-readable touch-screen display, with an extended life battery, and an internal or external antenna that allows aircraft maintainers to quickly and easily test various aircraft avionics systems with ease.

Canada and the USA

T-RX™ is available in three variants for customers based in Canada and the USA. The standard tests for each variant are listed below, however, the T-RX™ Radio and Pulse are capable of adding additional optional tests to suit your needs. Simply contact CCX Technologies Inc. to order your additional optional tests.

Europe

The T-RX™ RP+ is the only option for Europe.

Rest of the World

The T-RX™ RP+ is the only option for customers outside Canada and the USA. Some restrictions may apply.

T-RX™ Radio

VOR Generation	RF Level, Frequency, and bearing
ILS	Instrument Landing System components
Localizer	RF Level, Frequency, Deviation, and Tone
Glideslope	RF Level, Frequency, and Deviation
Marker Beacon	RF Level and Tone
VHF Com Generation	RF Level, Frequency, and Tone
VHF Com Receive	Frequency, Power, Modulation Level

T-RX™ Pulse

Transponder Mode A/C	Power, Frequency, Receiver Sensitivity, SLS, Mode A code and Mode C altitude
Transponder Mode S	Power, Frequency, Receiver Sensitivity, SLS, Mode A code and Mode C altitude, Mode S parameters
ADS-B OUT 1090	ADS-B OUT parameters
MODE-S GICB	All MODE-S GICB Registers including ELS and EHS parameters

T-RX™ RP+

Includes all of the features of the T-RX™ Radio, T-RX™ Pulse and the tests below.

Optional Tests

SELCAL	32 Tone SELCAL generation in HF and VHF Bands
ELT 406	406MHz ELT power, frequency, and reply decoding
ADS-B OUT 978	Receiver sensitivity, power, frequency, ADS-B OUT parameters
ADS-B IN 1090	ADS-B/TIS-B/ADS-R 1090 Traffic Target Generation
DME	DME distance/velocity testing
TCAS	TCAS Traffic Target Generation
ARINC 429	ARINC 429 Receive testing

Optional Tests not included in T-RX™ RP+

GPS GENERATOR	GPS Generator (requires additional hardware)
----------------------	--

Getting Started

What's in the box?

- T-RX™ w/Li-ion smart battery installed (Figure 1)
- Charging Cable



Figure 1

Optional Accessory Kit includes:

- Nanuk case (Figure 2)
- External Antenna (Figure 5)
- Extra battery (Figure 4)
- Battery charging dock (Figure 3)



Figure 2

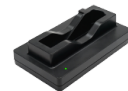

Figure 3



Figure 4



Figure 5

Charge your T-RX™ internal battery

Your T-RX™ will arrive with the battery installed. Connect your charging cable to the charging port (Item 8, Figure 6). Your battery will be fully charged when the middle LED stops blinking and is solid green.

Connector Dust Covers

Your T-RX™ will arrive with dust covers on all connections except for the charging port. These covers are recommended for shipping but are optional during use. For environments where FOD is a concern, these covers can be left off during use and during storage in the shipping case.

How does it work?

Press the power button (Item 1, Figure 6) to turn on your T-RX™. The first menu option at the top left section of the screen defaults to TESTS. Select the dropdown menu next to the TESTS menu and select the desired test function. Various configurable options for the selected test will now be available.

How to set up?

How do I connect the external antenna?

The T-RX™ has two internal antennas (automatically selected by frequency), but you may need to use the external antenna on certain occasions. Connect the provided external antenna to the TNC connector (item 6, Figure 6).

NOTE: For Com/VOR/ILS/ELT an external antenna will have higher gain than the internal antenna.

NOTE: The supplied external antenna is not appropriate nor is it calibrated for L-Band tests (Transponder, ADS-B, DME).

How do I adjust the screen brightness?

Select the TESTS menu at the top left section of the screen. Select CONFIGURE/SETTINGS/DISPLAY. Slide the Backlight Brightness to the desired level.

How do I calibrate the T-RX™ touchscreen?

Software versions 1.5.x and earlier: Select the TESTS menu at the top left section of the screen. Select CONFIGURE/SETTINGS/DISPLAY. Select TOUCHSCREEN CALIBRATE. Follow the on-screen instructions to calibrate.

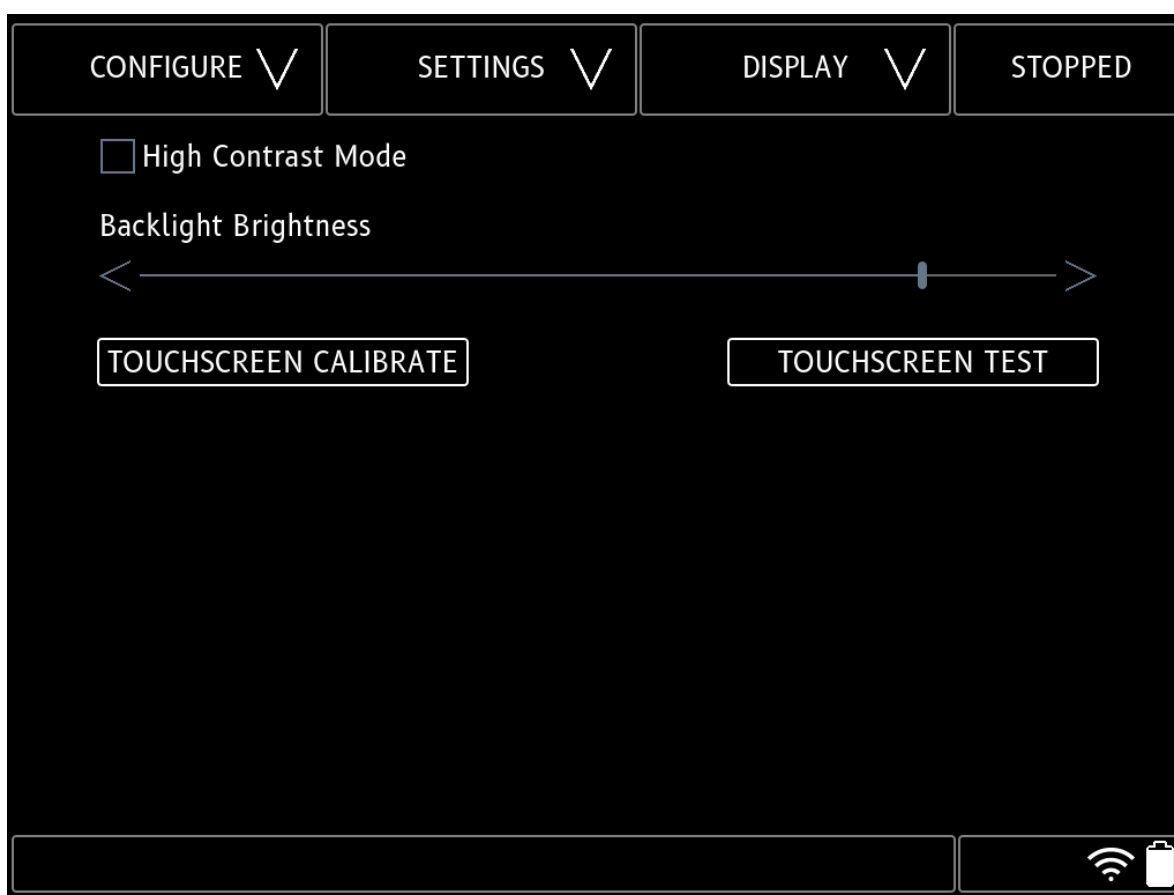

In software versions 1.6.x and higher, screen calibration is performed using a web browser. Connect Ethernet 1 (Figure 6, Item 3) of the T-RX™ to a network, or connect via WiFi, an IP address will then be assigned.

Navigate to the CONFIGURE/SETTINGS/ETHERNET or CONFIGURE/SETTINGS/WIFI page (top left pull-down menu) and retrieve the T-RX™ IP address.

For automatic assignment of IP address, DHCP can be selected or manual IP address/length (in CIDR format) can be assigned.

From a device:

1. Launch a web browser
2. Enter the IP address assigned to the T-RX™ in the CONFIGURE -> WIFI or CONFIGURE -> ETHERNET page
3. Login to the portal with Username **admin** and Password **admin**
4. Select SERVICES -> T-RX CALIBRATION and select TOUCHSCREEN CALIBRATE or TOUCHSCREEN TEST
5. Follow instructions on T-RX™ screen to calibrate

How do I change the T-RX™ touchscreen to High Contrast Mode?

Select CONFIGURE/SETTINGS/DISPLAY. Select the "High Contrast Mode" box.

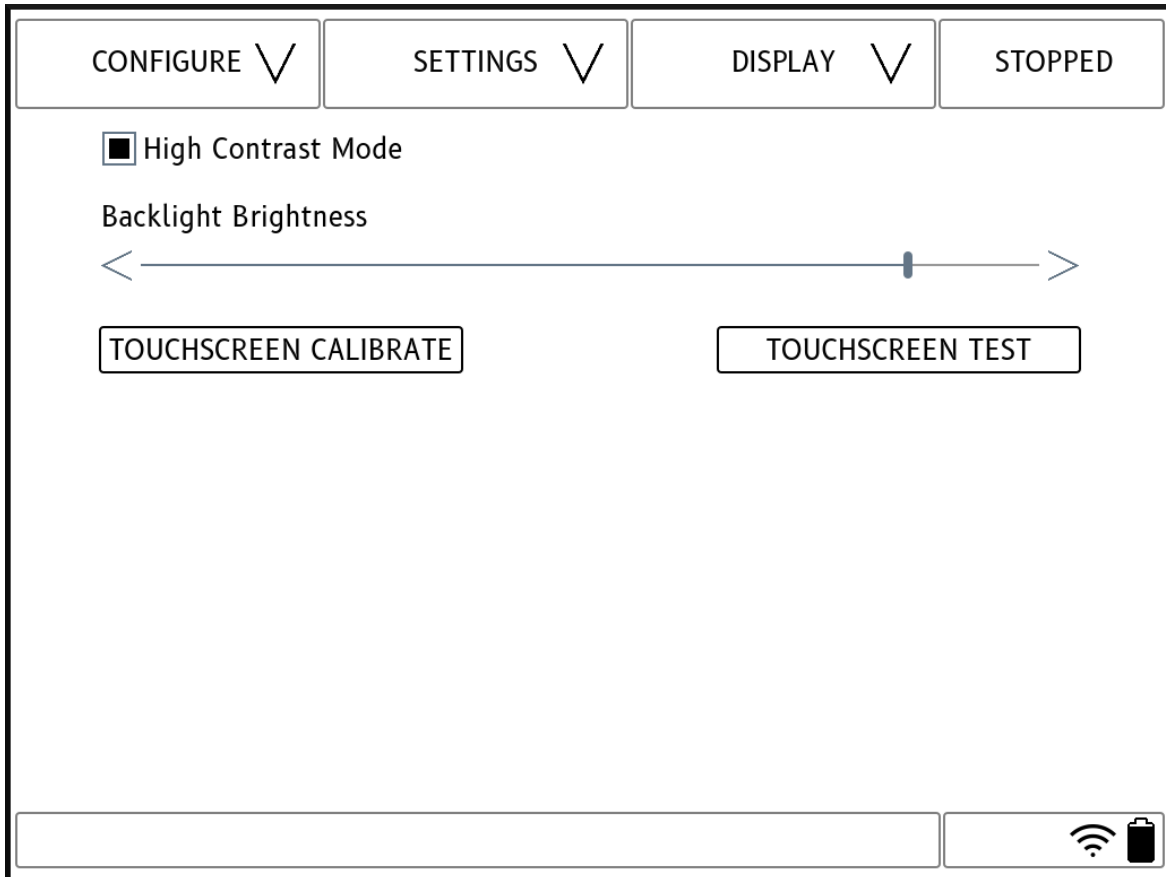

How do I connect to an Ethernet network?

Connect an Ethernet cable to the top Ethernet port. Select CONFIGURE/SETTINGS/ETHERNET. An IP address will be automatically assigned if DHCP is selected, or if DHCP is deselected enter an address and subnet in CIDR format (x.x.x.x/xx).



How do I connect to a Wi-Fi network?

Select CONFIGURE/SETTINGS/WIFI. Select Enable Client and DHCP. Enter up to 2 SSID and WPA/WPA2 passwords (password may be left blank for open networks). An IP address will be automatically assigned if DHCP is selected, or if DHCP is deselected enter an address and subnet in CIDR format (x.x.x.x/xx).

The screenshot displays the configuration interface for the T-RX device, specifically the Wi-Fi settings page. The interface is dark-themed with white text and input fields. At the top, there are four tabs: CONFIGURE, SETTINGS, WIFI, and STOPPED. The WIFI tab is currently selected. Below the tabs, there are two columns of settings. The left column contains SSID 1 (with the value 'ajk312'), SSID 2 (empty), IP Address (with the value '192.168.86.97/24'), and an 'Enable Client' checkbox. The right column contains SSID 1 WPA Password (with the value '*****'), SSID 2 WPA Password (empty), and a 'DHCP' checkbox. At the bottom right, there are icons for Wi-Fi and battery status.

CONFIGURE	SETTINGS	WIFI	STOPPED
SSID 1	SSID 1 WPA Password		
ajk312	*****		
SSID 2	SSID 2 WPA Password		
IP Address	<input type="checkbox"/> DHCP		
192.168.86.97/24			
<input type="checkbox"/> Enable Client			

How do I configure an Access Point network?

Select CONFIGURE/SETTINGS/ACCESS POINT. Enter the SSID and WPA passwords, select the Operating Mode and Channel. Put the desired IP Address in the IP Address box. Select Enable Access Point, if the Access Point activates successfully then the indication circle turns green.

The screenshot shows a configuration screen with a dark background and white text. At the top, there are four tabs: CONFIGURE, SETTINGS, ACCESS POINT (selected), and STOPPED. Below the tabs, there are several input fields and controls:

- SSID:** A text box containing "CCX SystemX".
- Passphrase:** A text box containing "Password".
- Operating Band:** Two radio buttons, "2.4GHZ" (selected) and "5GHZ".
- Channel:** A dropdown menu showing "0".
- IP Address:** A text box containing "172.32.4.7/24".
- Enable Access Point:** A checked checkbox.
- Access Point Active:** An unchecked radio button.

At the bottom right, there are icons for Wi-Fi and battery status.

About System Page

Select CONFIGURE/ABOUT/SYSTEM. T-RX Software Version , FPGA Version , Serial Number , Calibration Date and License Group are shown.

Note: Calibration Date not shown if calibration performed prior to 17 July 2020.

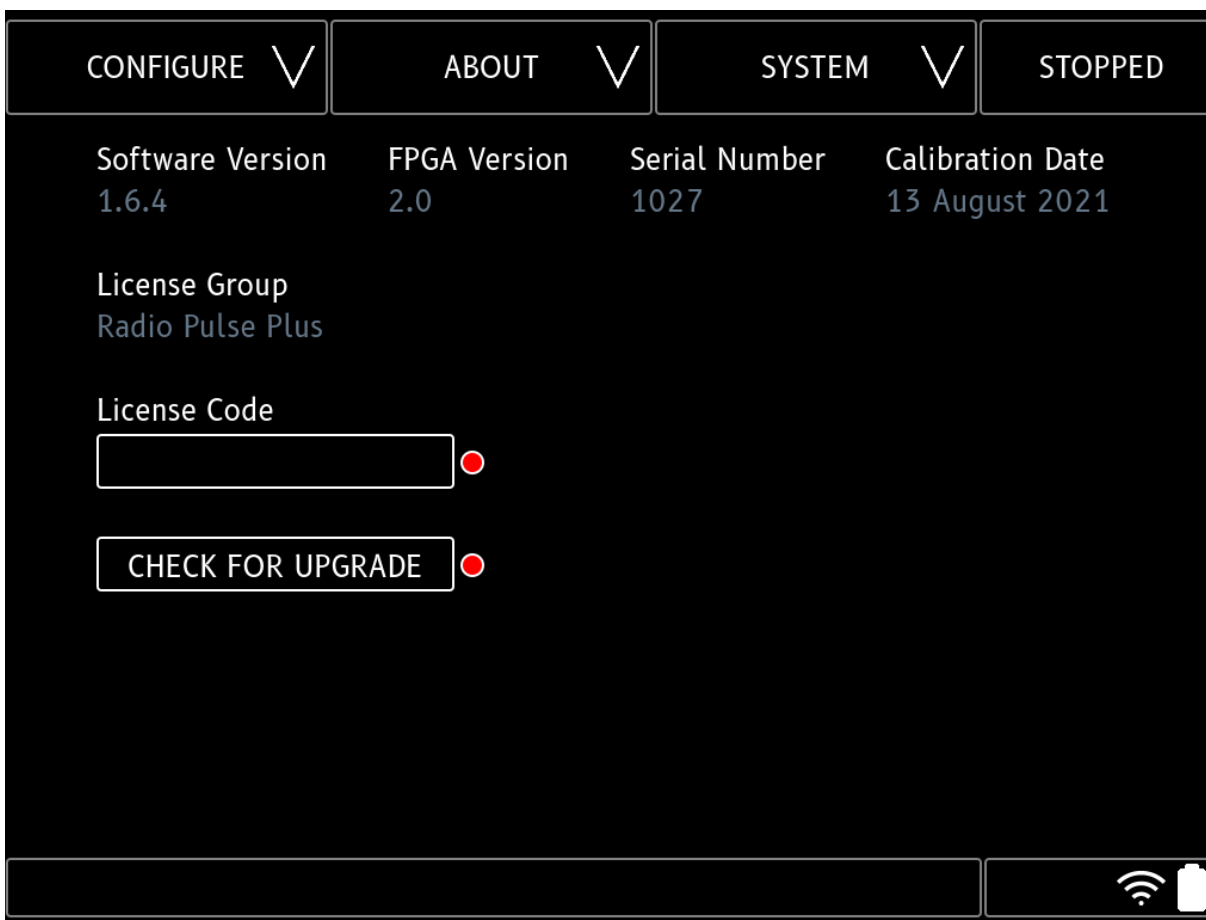

Check for upgrade

Software can be upgraded from the public CCX upgrade server with software 1.5.x and higher. Select **CONFIGURE/ABOUT**. Select **CHECK FOR UPGRADE**. If there is an upgrade available, there will be a green indicator. A new option **UPGRADE FROM SERVER** will pop up to download and upgrade. Select **UPGRADE FROM SERVER**, it will start downloading. After completing the upgrade, it will show the Upgrade Complete message. The system will automatically reboot. **Note: The T-RX must have Internet access from WiFi or Ethernet in order to use this feature.**

About Support Page

Select CONFIGURE/ABOUT/SUPPORT. T-RX CONTROLS will show an image with labels of the connections/controls and LEDs on the front of the T-RX.

USER MANUAL will show the complete T-RX User Manual.

Enable Remote Support will allow CCX Tech Support to remotely connect to the T-RX for troubleshooting. See Troubleshooting section for more details.



T-RX Controls

CONFIGURE ▾
ABOUT ▾
SUPPORT ▾
STOPPED



− 1 +

+

−

◀ ▶

⬆ ⬇

1	Power	On/Off
2	USB	USB Headset or GPS Generator
3	Ethernet 1	Used for retrieving test data and loading of software upgrades.
4	Ethernet 2	Reserved for future use
5	ARINC 429	ARINC 429: 1/2 RX 1, 4/5 RX2, 7/8 TX, 3/6/9/10 GND
6	External Connection	Connection to a receiver, or an external antenna
7	Direct Transmitter Connection	Connects directly to a transmitter, such as a VHF com, Transponder, or DME. It can also be used for bench testing of these components. Also required if using a Transponder antenna coupler. Note: Direct Port has a transmit 50 ohm load attached internally. For high power continuous transmit sources (VHF/HF Com) over 5W, observe a 30 second on, 1 minute off duty cycle. Pulse sources (Transponder, DME, ADS-B) can be used continuously.
8	Charging Port	Used for charging the internal T-RX™ battery

📶
🔋

CONFIGURE ▾
ABOUT ▾
SUPPORT ▾
STOPPED



− 2 +

+

−

◀ ▶

⬆ ⬇

Top LED	Power Indicator	Solid Green - On
Middle LED	Charging Indicator	Solid Green - Full Battery Flashing Amber - Charging
Bottom LED	Test State Indicator	Solid Green - No Test Solid Amber - Running Test Solid Blue - Booting Device

📶
🔋

How do I change the battery?

Step 1 Using a #2 Phillips screwdriver, remove (4 ea) captive screws on the right end cap.

Step 2 Slide the right end cap off.

Step 3 Using the tab on the battery, pull the battery out.

Step 4 Slide the replacement battery into the battery port.

Step 5 Place the right end cap back onto the T-RX™.

Step 6 Reinstall the (4 ea) screws that secure the end cap.

Getting Technical



Figure 6 - T-RX™ Connectors

Connector Info

1	Power	On/Off
2	USB	USB Headset or GPS Generator
3	Ethernet 1	Used for retrieving test data and loading of software upgrades. T-RX™ is a DHCP client
4	Ethernet 2	Reserved for future use
5	ARINC 429	ARINC 429 TX/RX
6	External Connection	<p>Connection to a receiver, or an external antenna.</p> <p>⚠ Do not connect a transmitter to this port. Excessive RF energy can damage the T-RX RF input.</p>
7	Direct Transmitter Connection	<p>Connects directly to a transmitter, such as a VHF com, Transponder, or DME. It can also be used for bench testing of these components. Also required if using a Transponder antenna coupler.</p> <p>⚠ Note: Direct Port has a transmit 50 ohm load attached internally. For high power continuous transmit sources (VHF/HF Com) over 5W, observe a 15 second on, 1 minute off duty cycle. Pulse sources (Transponder, DME, ADS-B) can be used continuously.</p> <p>WARNING: CW RF SOURCES OVER 25W MUST USE AN EXTERNAL ATTENUATOR TO LIMIT POWER AT DIRECT PORT TO <25W!</p>

8 External Charging Port Used for charging the internal T-RX™ battery



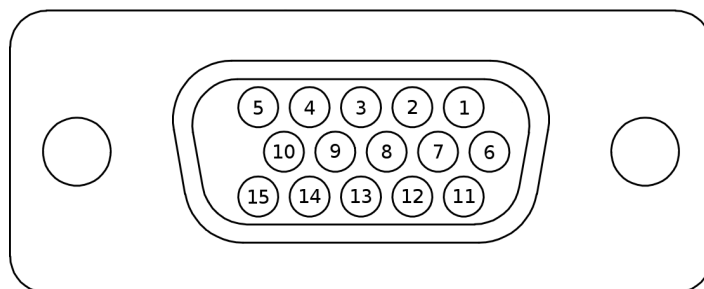

ARINC 429 Connector Pinout



Pin	Function	Pin	Function	Pin	Function	Pin	Function	Pin	Function
1	A429 RX 1A	2	A429 RX 1B	3	GND	4	A429 RX 2A	5	A429 RX 2B
6	GND	7	A429 TX A	8	A429 TX B	9	GND	10	GND
11	NC	12	NC	13	NC	14	NC	15	NC

ARINC-429 Mating Connector

ARINC-429 signals in your installation can be broken out to an HD D-Sub connector and connected to the T-RX. The following parts are recommended for use in your breakout cable. Consult the part datasheets for assembly instructions and your wiring diagrams for equipment-specific ARINC-429 pinouts.

Part Name	US Military Standard Part Number	Photo	Description
Housing	M24308/4-11		Connector, 15-Pin Male, High-Density Plug or compatible
Pin	M39029/58-360		Contact Pin, Male, 22-28AWG, Crimp, Gold
Insertion/ Extraction Tools	M81969/1-04		Extraction, Removal & Insertion Tool
Crimper & Positioner	M22520/2-01 and M22520/2-09		Hand Crimper Tool, 22-28AWG, Side

LED Indicators



Test Details

T-RX™ has an easy to use intuitive graphical user interface. To begin testing, start by ensuring the top left menu is set to "TESTS". Next press the menu to the right of "TESTS" to display all available test options for your T-RX™. Select the test you wish to perform, and adjust the options for that test as needed. When the options for your test are correctly set press "RUN" to begin the test.

User Input



All sliders can be moved directly using the touchscreen, or by entering via an on screen numeric keyboard by touching the control value. For RF levels, enter as negative values (for example -15). Text fields will raise an alphanumeric keyboard.

Keyboard can be hidden by pressing the Keyboard Hide or Enter icons.

Some sliders have decrement/increment arrow keys, others may have presets.

Antenna/Port Selection



Internal Antenna	Internal antenna is selected by de-selecting both EANT and DRCT
EANT	Select EANT for external antenna or connection to a receiver
DRCT	Select DRCT for Direct connection with internal 40 dB load/attenuator. Intended for connections with transmitters such as VHF/HF Com, Dme, Transponder, ADS-B OUT. Also appropriate for low loss antenna couplers.

Note: Software 1.5.x and earlier antenna/port selections were independent settings for each test and DRCT could not be selected for any NAV tests.

Starting with 1.6.x software, antenna settings are persistent between tests. If DRCT port is selected in a NAV, COM, or SELCAL test, the generator output range is restricted to no more than -40 dBm due to the internal attenuator/load on the DRCT port.

Antenna Use

Internal Antenna - Can be used for all tests, although gain will be low for HF frequencies. For HF COM, VHF COM, and NAV tests, a whip antenna connected to the EANT port will provide greater range. For L-Band/Pulse tests, the internal antenna is directional and the back of the T-RX™ should be pointed at the aircraft antenna.

Whip Antenna - Appropriate for HF, COM, and NAV tests. Connect to External Port (EANT). The whip antenna is **not suitable for Pulse applications**.

L-Band (Pulse) Antenna Couplers - A coupler which clamps onto the L-Band/Pulse antenna may be used, and is recommended for altitude correspondence testing to prevent interference with ATC or TCAS systems. See FAA SAFO 17002 for further information about proper test procedures when altimeter systems are exercised during testing. The combined Coupler and coax loss must be programmed in the application TEST CONFIG section as External Loss. Most couplers are very low loss (less than 1 dB), and the **Direct port connection must be used**.

L-Band Directional Antenna - CCX does not supply an L-Band directional antenna, but the T-RX™ is compatible with any directional antenna with calibrated loss at the frequency of use.

VOR Test

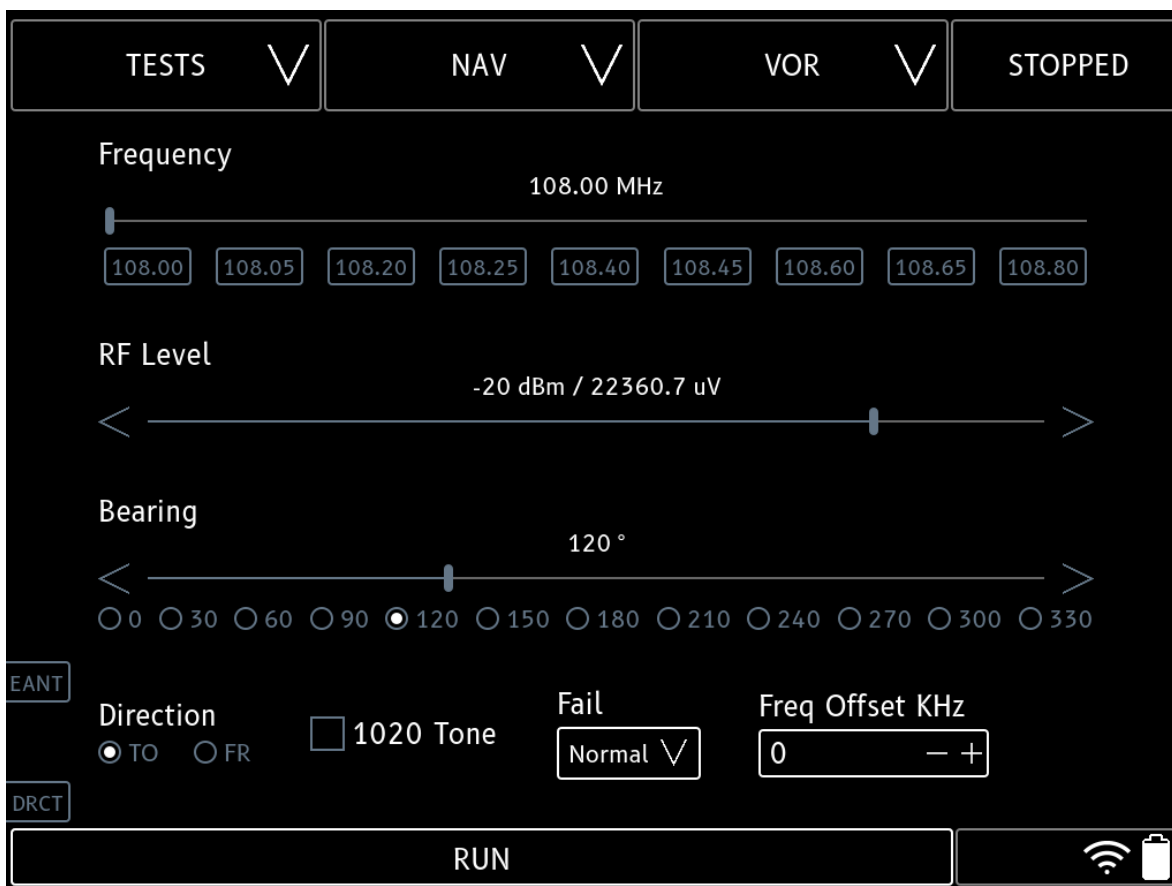

Frequency (MHz)	Select the desired frequency by selecting a preset, using the slider, or selecting frequency number and using keypad
RF Level (dBm / uV)	Set the RF level with the slider, < > decrement/increment arrows, or selecting level number and using keypad
Bearing	Select from a preset, slider, or selecting bearing number and using keypad
Direction	Select To or From
1020 Hz Tone	On or off
Fail	Select from Normal, Ref, Var, or Both. Selecting Ref, Var, or Both will cause a VOR fail flag
Freq Offset	Generated frequency can be offset for selectivity testing
EANT	Select EANT for external antenna or no selection for the internal antenna
RUN/CANCEL	Selecting RUN will output the signal continuously until CANCEL is selected

ILS Test

The screenshot displays the ILS Test configuration screen. At the top, there are four tabs: TESTS (selected), NAV, ILS, and STOPPED. Below the tabs, the following controls are visible:

- Frequency:** A slider set to 108.10 MHz with preset buttons at 108.10, 108.15, 108.30, 108.35, 108.50, 108.55, 108.70, 108.75, and 108.90.
- RF Level:** A slider set to -20.0 dBm / 22360.7 uV, with left and right arrow controls.
- Localizer Deviation:** A slider set to 0.000 DDM, with left (L) and right (R) arrow controls. Preset buttons are at -0.155, -0.093, -0.078, -0.046, 0, 0.046, 0.078, 0.093, and 0.155.
- Glideslope Deviation:** A slider set to 0.000 DDM, with up (UP) and down (DN) arrow controls. Preset buttons are at -0.175, -0.091, -0.088, -0.045, 0, 0.045, 0.088, 0.091, and 0.175.
- EANT:** A button for external antenna selection.
- DRCT:** A button for direct mode selection.
- RUN:** A large button to start the test.
- Icons:** Wi-Fi and battery status icons in the bottom right corner.

Frequency (MHz)	Select the desired frequency by selecting a preset, using the slider, or selecting frequency number and using keypad
RF Level (dBm / uV)	Set the RF level with the slider, < > decrement/increment arrows, or selecting level number and using keypad. RF levels are -48dBm <-> 0 dBm, uncalibrated in ILS mode.
Localizer Deviation (DDM)	Select from a preset, slider, or selecting DDM number and using keypad
Glideslope Deviation (DDM)	Select from a preset, slider, or selecting DDM number and using keypad
EANT	Select EANT for external antenna or no selection for the internal antenna
RUN/CANCEL	Selecting RUN will output the signal continuously until CANCEL is selected

Localizer Test

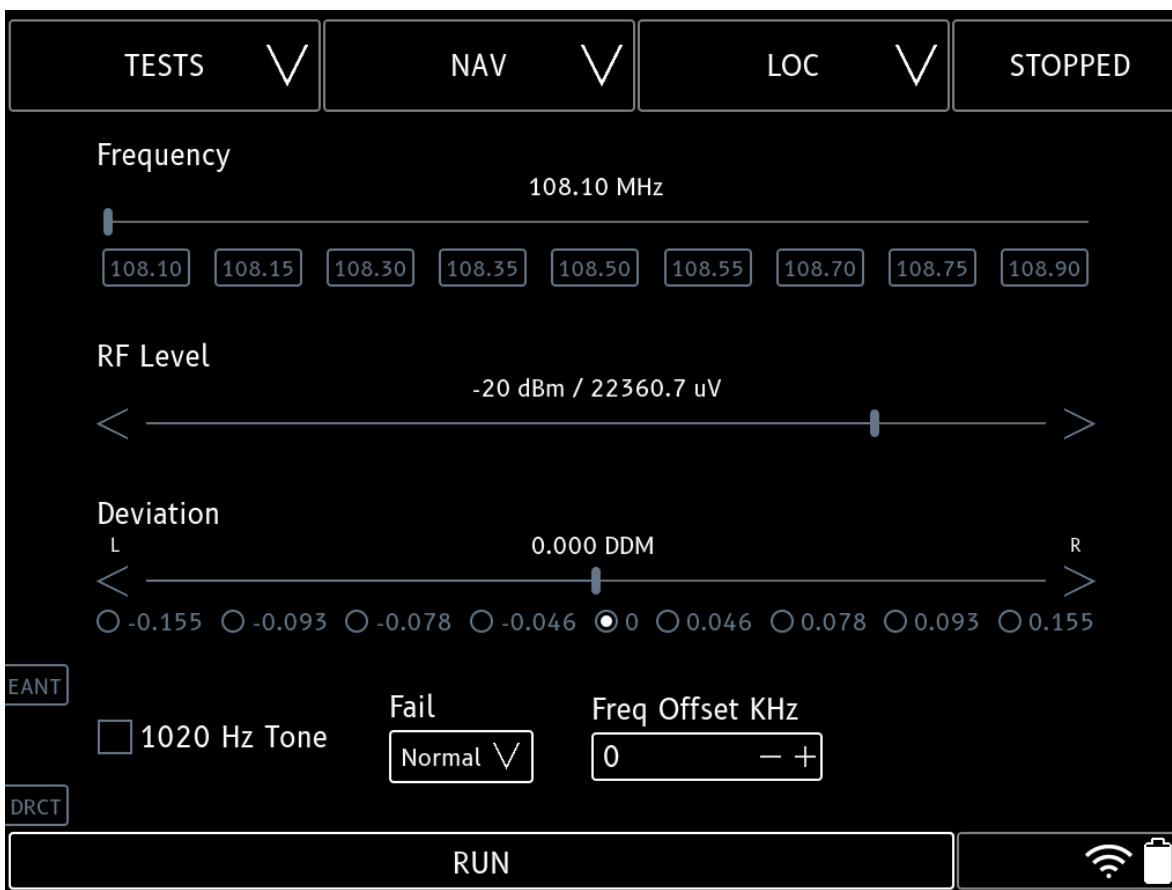

Frequency (MHz)	Select the desired frequency by selecting a preset, using the slider, or selecting frequency number and using keypad
RF Level (dBm / uV)	Set the RF level with the slider, < > decrement/increment arrows, or selecting level number and using keypad
Deviation (DDM)	Select from a preset, slider, or selecting DDM number and using keypad
1020 Hz Tone	On or off
Fail	Select from NORMAL, 90HZ, 150HZ, or BOTH. Selecting 90HZ, 150HZ, or BOTH will cause an LOC fail flag
Freq Offset	Generated frequency can be offset for selectivity testing
EANT	Select EANT for external antenna or no selection for the internal antenna
RUN/CANCEL	Selecting RUN will output the signal continuously until CANCEL is selected

Glideslope Test

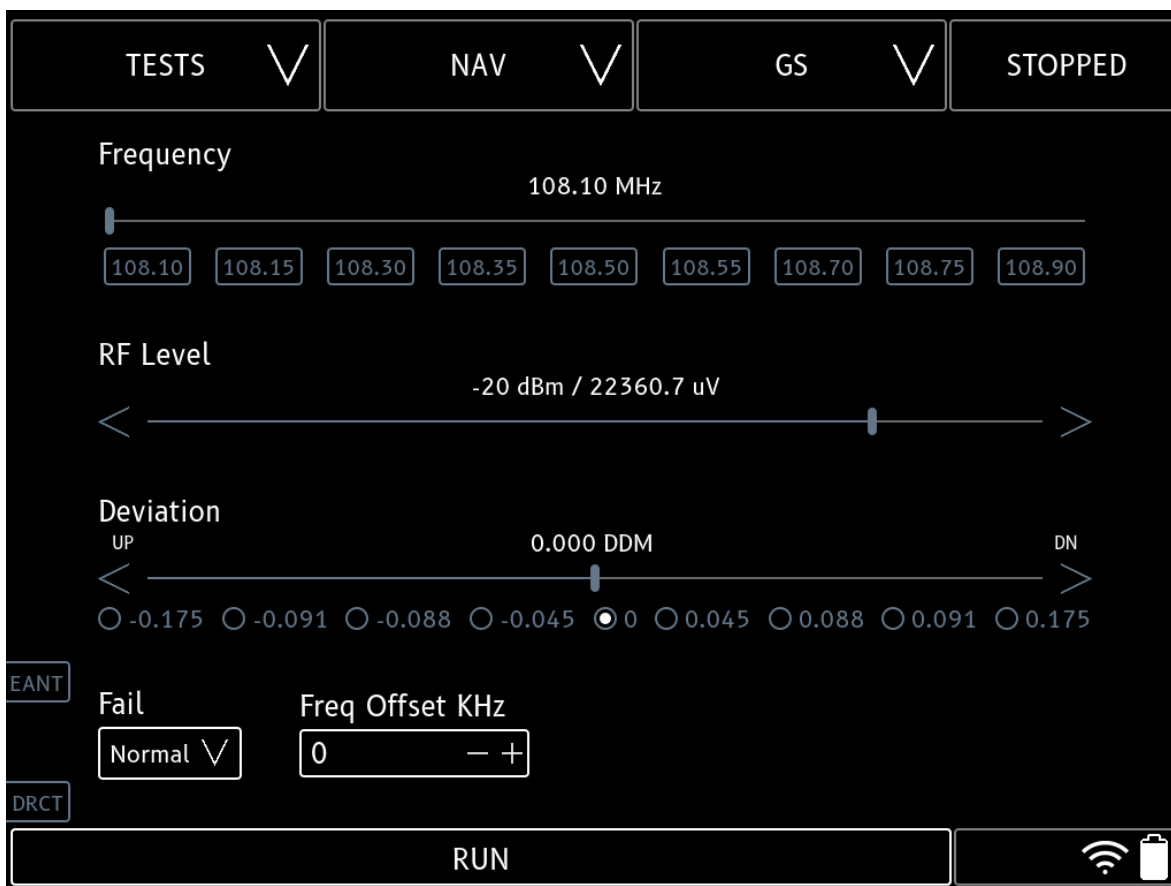

Frequency (MHz)	Select the desired frequency by selecting a preset, using the slider, or selecting frequency number and using keypad
RF Level (dBm / uV)	Set the RF level with the slider, < > decrement/increment arrows, or selecting level number and using keypad
Deviation (DDM)	Select from a preset, slider, or selecting DDM number and using keypad
Fail	Select from NORMAL, 90HZ, 150HZ, or BOTH. Selecting 90HZ, 150HZ, or BOTH will cause a GS fail flag
Freq Offset	Generated frequency can be offset for selectivity testing
EANT	Select EANT for external antenna or no selection for the internal antenna
RUN/CANCEL	Selecting RUN will output the signal continuously until CANCEL is selected

Marker Beacon Test

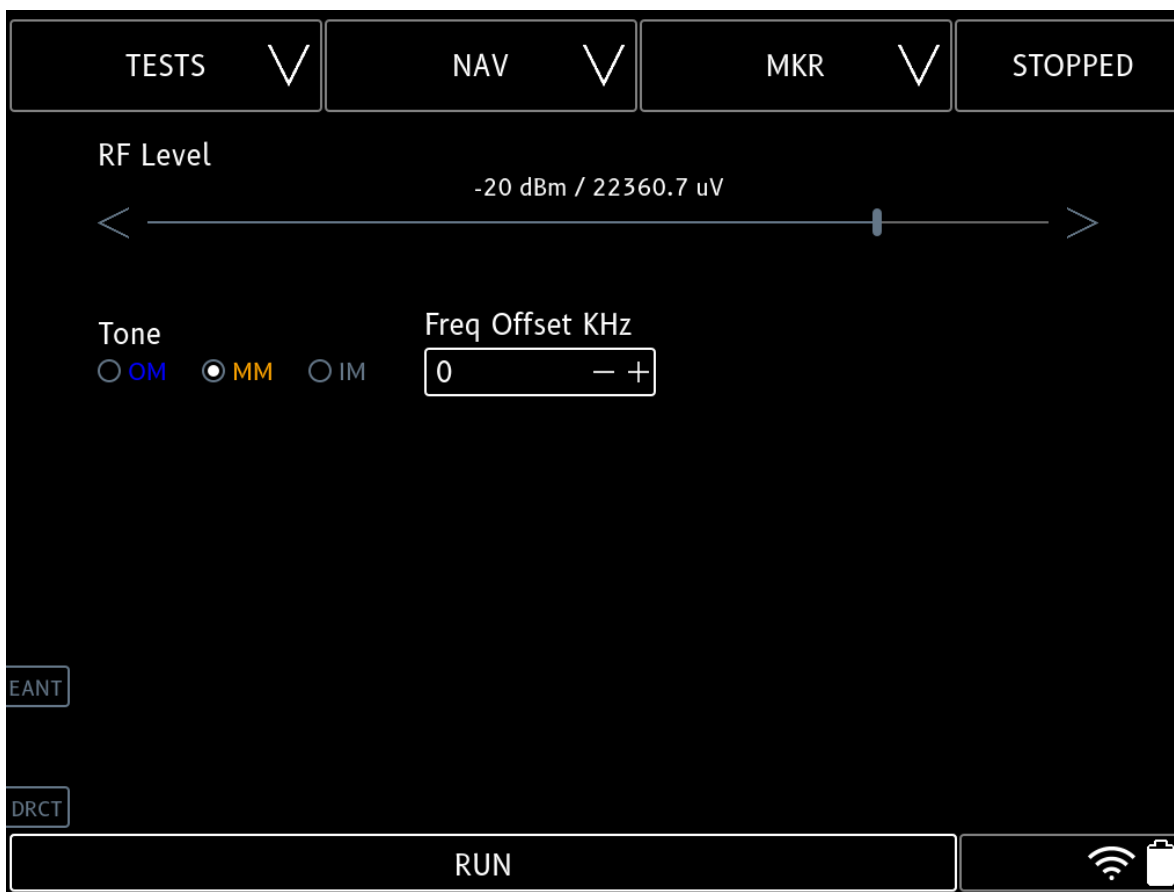

RF Level (dBm / uV)	Set the RF level with the slider, < > decrement/increment arrows, or selecting level number and using keypad
Tone	Choose from outer marker, middle marker, inner marker. Selection color matches Marker Annunciator color
Freq Offset	Generated frequency can be offset for selectivity testing
EANT	Select EANT for external antenna or no selection for the internal antenna
RUN/CANCEL	Selecting RUN will output the signal continuously until CANCEL is selected

VHF Com Generate Test



1020 Hz Tone	On or off
Frequency (MHz)	Select the desired frequency or 8.33 KHz channel by using the slider, < > decrement/increment arrows, or selecting frequency/channel number and using keypad
RF Level (dBm / uV)	Set the RF level with the slider, < > decrement/increment arrows, or selecting level number and using keypad
Freq Offset	Generated frequency can be offset for selectivity testing
EANT/DRCT	Select EANT for the external antenna, DRCT for a direct connection, or no selection for the internal antenna
RUN/CANCEL	Selecting RUN will output the signal continuously until CANCEL is selected

VHF Com Receive Test

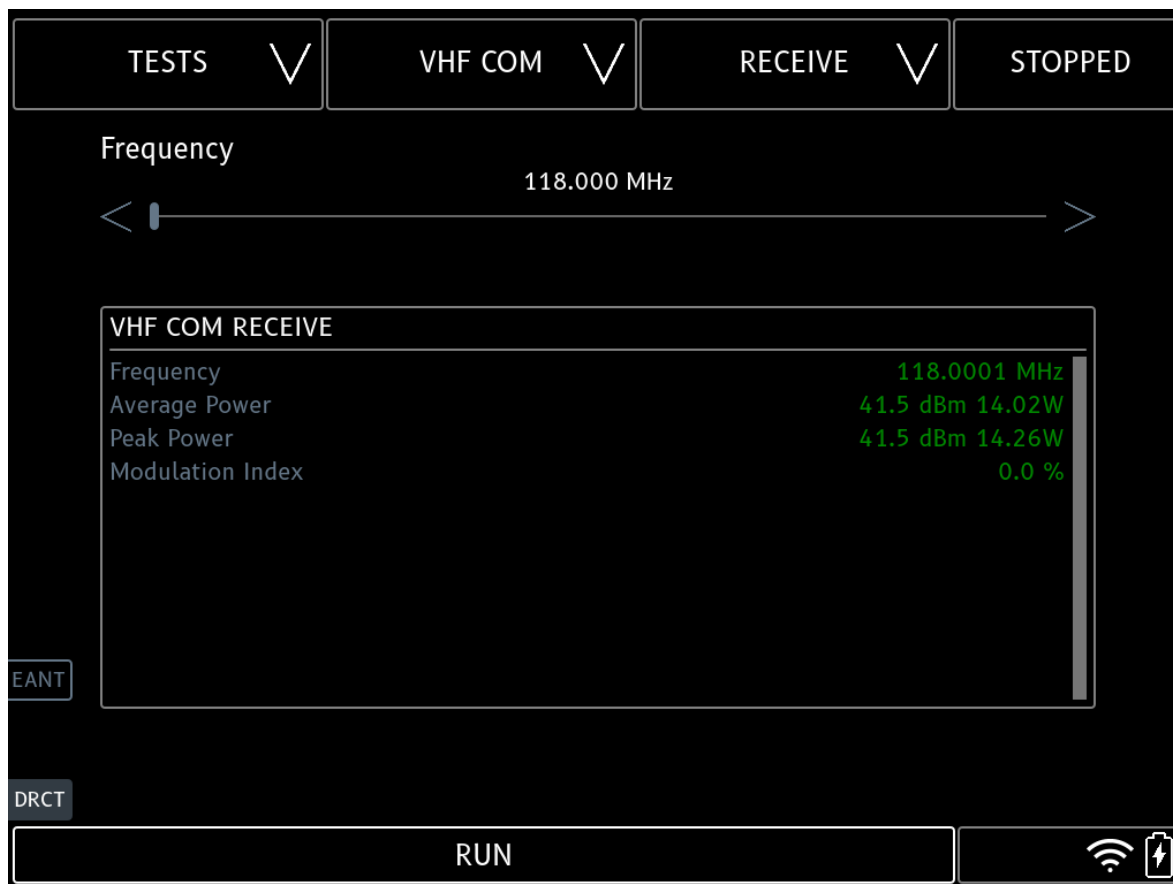

Frequency (MHz)	Select the desired frequency or 8.33 KHz channel by using the slider, <> decrement/increment arrows, or selecting frequency/channel number and using keypad
EANT/DRCT	Select EANT for the external antenna, DRCT for a direct connection, or no selection for the internal antenna
RUN/CANCEL	Selecting RUN will receive the signal continuously until CANCEL is selected
Frequency Result	Measured frequency with a resolution of 100 Hz
Average Power Result	Measured Average Power in dBm and Watts. Only displayed when Direct port is selected
Peak Power Result	Measured Peak Power in dBm and Watts. Only displayed when Direct port is selected
RSSI Result	A relative measure of received power when External or Internal port is selected
Modulation Index Result	Measured Modulation percentage. Only accurate with single tone modulation

Receive Audio

A USB headset can be used to listen to transmitter modulation. Insert USB plug in T-RX USB receptacle before starting test.

ELT 121.5 Testing

An ELT with 121.5 MHz output can be tested with the VHF Com Receive Test.

Test Setup:

Select 121.5 MHz.

Use Direct port

Use Peak Power for ELT power

Use USB headset for ELT modulation

HF Com Generate Test



1020 Hz Tone	On or off
Frequency (MHz)	Select the desired frequency by using the slider, < > decrement/increment arrows, or selecting frequency number and using keypad
RF Level (dBm / uV)	Set the RF level with the slider, < > decrement/increment arrows, or selecting level number and using keypad
Mode	Upper Sideband (USB) or Amplitude Modulation (AM)
EANT/DRCT	Select EANT for the external antenna, DRCT for a direct connection, or no selection for the internal antenna
RUN/CANCEL	Selecting RUN will output the signal continuously until CANCEL is selected

HF Com Receive Test



Frequency (MHz)	Select the desired frequency by using the slider, < > decrement/increment arrows, or selecting frequency number and using keypad
Mode	Upper Sideband (USB) or Amplitude Modulation (AM)
EANT/DRCT	Select EANT for the external antenna, DRCT for a direct connection, or no selection for the internal antenna
RUN/CANCEL	Selecting RUN will receive the signal continuously until CANCEL is selected
Frequency Result	Measured frequency with a resolution of 100 Hz
Average Power Result	Measured Average Power in dBm and Watts. Only displayed when Direct port is selected
Peak Power Result	Measured Peak Power in dBm and Watts. Only displayed when Direct port is selected
RSSI Result	A relative measure of received power when External or Internal port is selected

Receive Audio

A USB headset can be used to listen to transmitter modulation. Insert USB plug in T-RX USB receptacle before starting test.

SELCAL Test

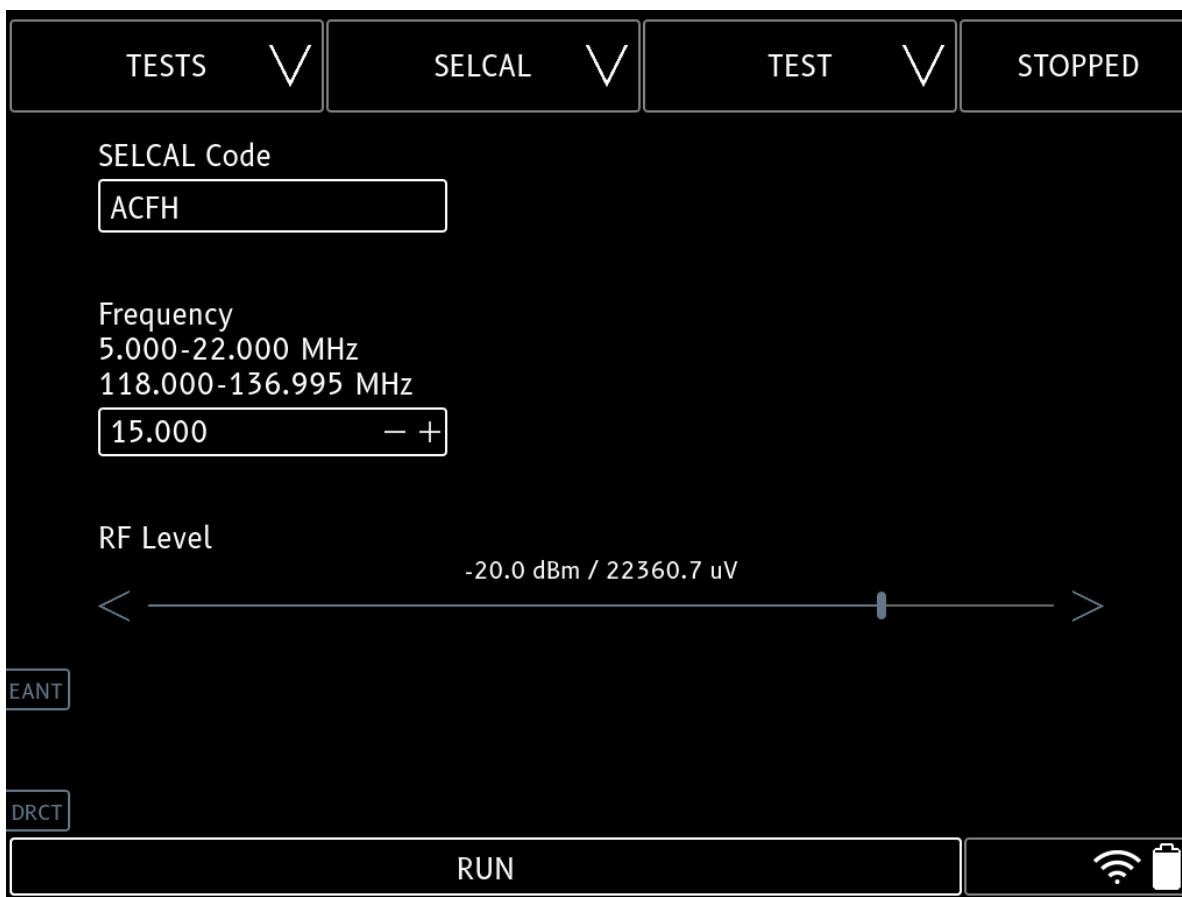

SELCAL Code	Enter a 16 or 32 Tone SELCAL Code
Frequency (MHz)	Enter the desired frequency
RF Level (dBm / uV)	Set the RF level with the slider, < > decrement/increment arrows, or selecting level number and using keypad
EANT/DRCT	Select EANT for the external antenna, DRCT for a direct connection, or no selection for the internal antenna
RUN/CANCEL	Selecting RUN will output the SELCAL code sequence then stop

ELT 406 Test

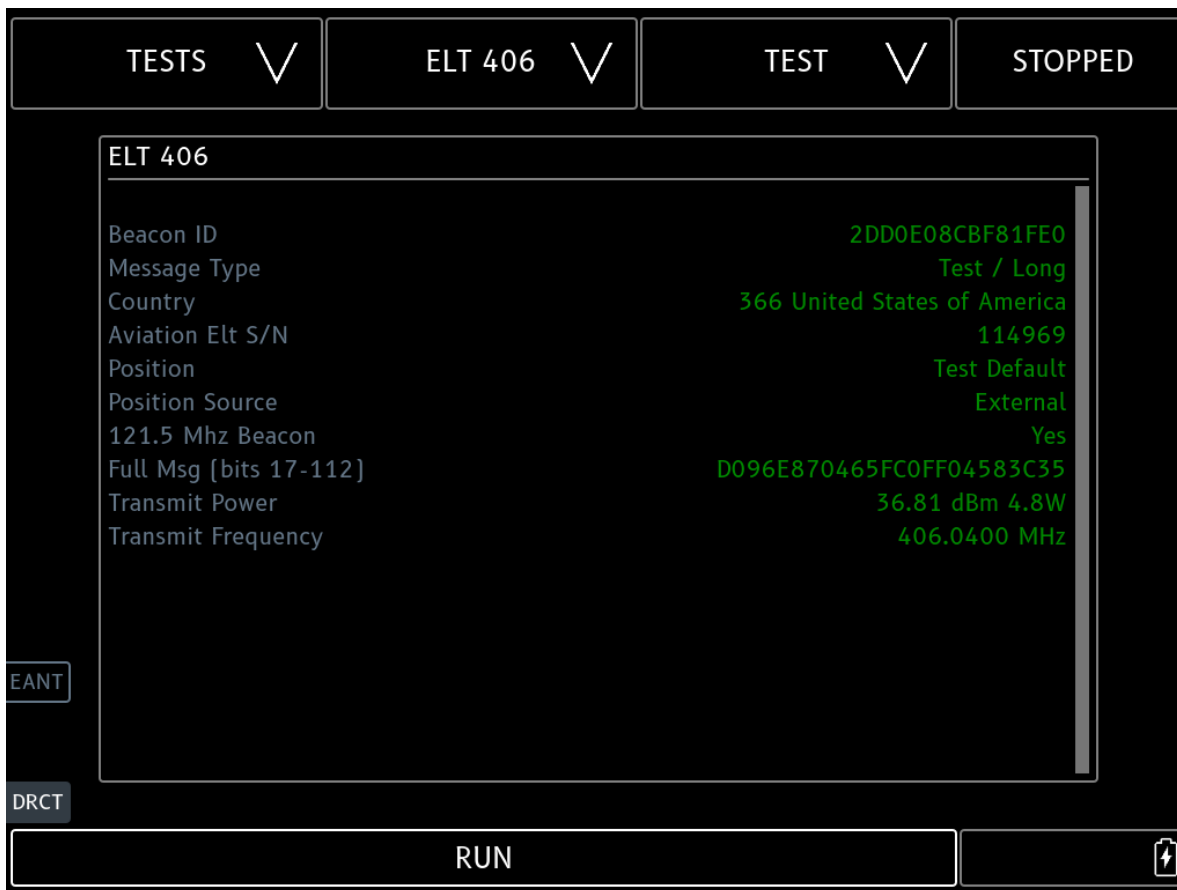

EANT/DRCT	Select EANT for an external antenna, DRCT for a direct connection, or no selection for the internal antenna
RUN/CANCEL	Selecting RUN will run the test until a 406 burst is decoded or CANCEL is selected

Note: Transmit Power is displayed only for DRCT connection.

ELT 406 Test Config



<p>External Loss (dB)</p>	<p>Applies to DRCT or EANT selections only. External loss refers to the loss of the coax connection when using the DRCT connection, or of the external antenna when using the EANT selection. Set the external loss by pressing < or >, or manually sliding to the required external loss level. See External Antenna section for more information</p>
<p>Distance (ft)</p>	<p>Applies to EANT or internal antenna selections only. Distance refers to the distance in feet from the antenna under test to the T-RX™ when using the EANT or internal antenna selections. Set the distance by pressing < or >, or manually sliding to the required distance</p> <p>NOTE: Over-the-air ELT reception is most reliable at distances of 10 ft or more.</p>

DME Test



EANT/DRCT	Select EANT for an external antenna, DRCT for a direct connection, or no selection for the internal antenna
Channel	Paired VOR/ILS frequency of DME
Range	Initial distance from DME ground station
Speed	Velocity to/from DME ground station

DME Test Config



<p>External Loss (dB)</p>	<p>Applies to DRCT or EANT selections only. External loss refers to the loss of the coax connection and optional coupler to a DME when using the DRCT connection, or of the external antenna when using the EANT selection. Set the external loss by pressing < or >, or manually sliding to the required external loss level. See External Antenna section for more information</p>
<p>Distance (ft)</p>	<p>Applies to EANT or internal antenna selections only. Distance refers to the distance in feet from the DME antenna under test to the T-RX™ when using the EANT or internal antenna selections. Set the distance by pressing < or >, or manually sliding to the required distance</p>

TCAS Test

The screenshot shows a black interface with white text and input fields. At the top, there is a horizontal menu with four items: 'TESTS', 'TCAS', 'TEST', and 'STOPPED', each with a downward-pointing chevron. Below the menu, there are four input fields arranged in a 2x2 grid. The top-left field is labeled 'Target Distance [nm]' and contains the value '25.0'. The top-right field is labeled 'Target Speed [kts]' and contains '0'. The bottom-left field is labeled 'Target Altitude [ft]' and contains '2500'. The bottom-right field is labeled 'Target Vert Rate [+ft/min]' and contains '0'. On the left side of the interface, there are two small buttons labeled 'EANT' and 'DRCT'. At the bottom, there is a large 'RUN' button in the center, and on the right side, there are icons for Wi-Fi and battery status.

EANT/DRCT	Select EANT for an external antenna, DRCT for a direct connection, or no selection for the internal antenna
Target Distance	Distance of TCAS target
Target Speed	Velocity of TCAS target (negative velocity will move target toward aircraft)
Target Altitude	Pressure altitude of TCAS target
Target Vert Rate	Vertical Rate of TCAS target

TCAS Test Config



<p>External Loss (dB)</p>	<p>Applies to DRCT or EANT selections only. External loss refers to the loss of the coax connection and optional coupler to a TCAS when using the DRCT connection, or of the external antenna when using the EANT selection. Set the external loss by pressing < or >, or manually sliding to the required external loss level. See External Antenna section for more information</p>
<p>Distance (ft)</p>	<p>Applies to EANT or internal antenna selections only. Distance refers to the distance in feet from the TCAS antenna under test to the T-RX™ when using the EANT or internal antenna selections. Set the distance by pressing < or >, or manually sliding to the required distance</p>

Transponder Mode A/C/S Test

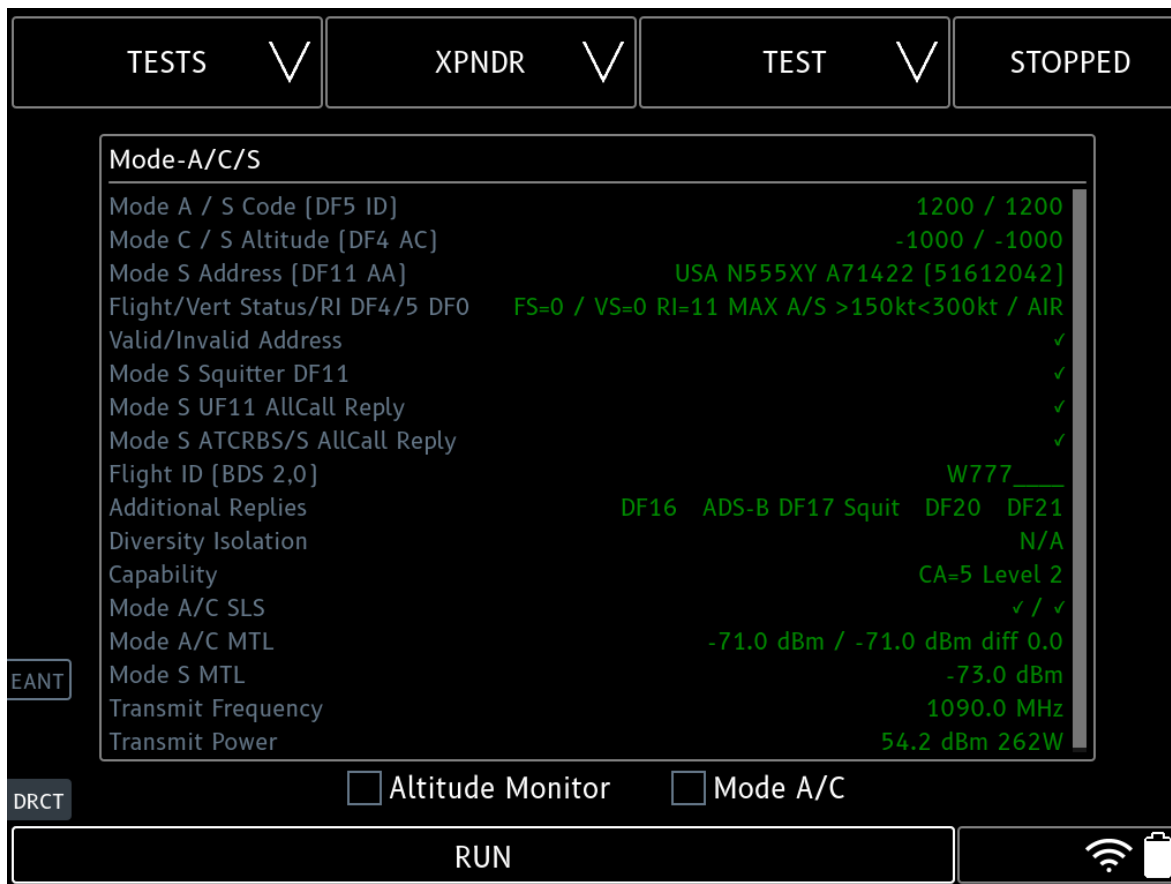

EANT/DRCT	Select EANT for an external antenna, DRCT for a direct connection, or no selection for the internal antenna
RUN/CANCEL	Selecting RUN will run the test continuously until CANCEL is selected. MODE-S will be automatically detected
Altitude Monitor	Altitude Monitor selected will only display altitude during a test for a higher update rate. Intended for Altitude Correspondence testing. Also shows Mode C altitude Gray code bits
Mode A/C	Select for Mode A/C transponder. Mode-S modes will not be interrogated
NOTE: A Transponder antenna coupler should only be attached to the DIRECT antenna port	
NOTE: Simultaneous use of GPS Generator Test and XPNDR Test is not recommended due to T-RX resources required by both tests.	

Transponder Test Config

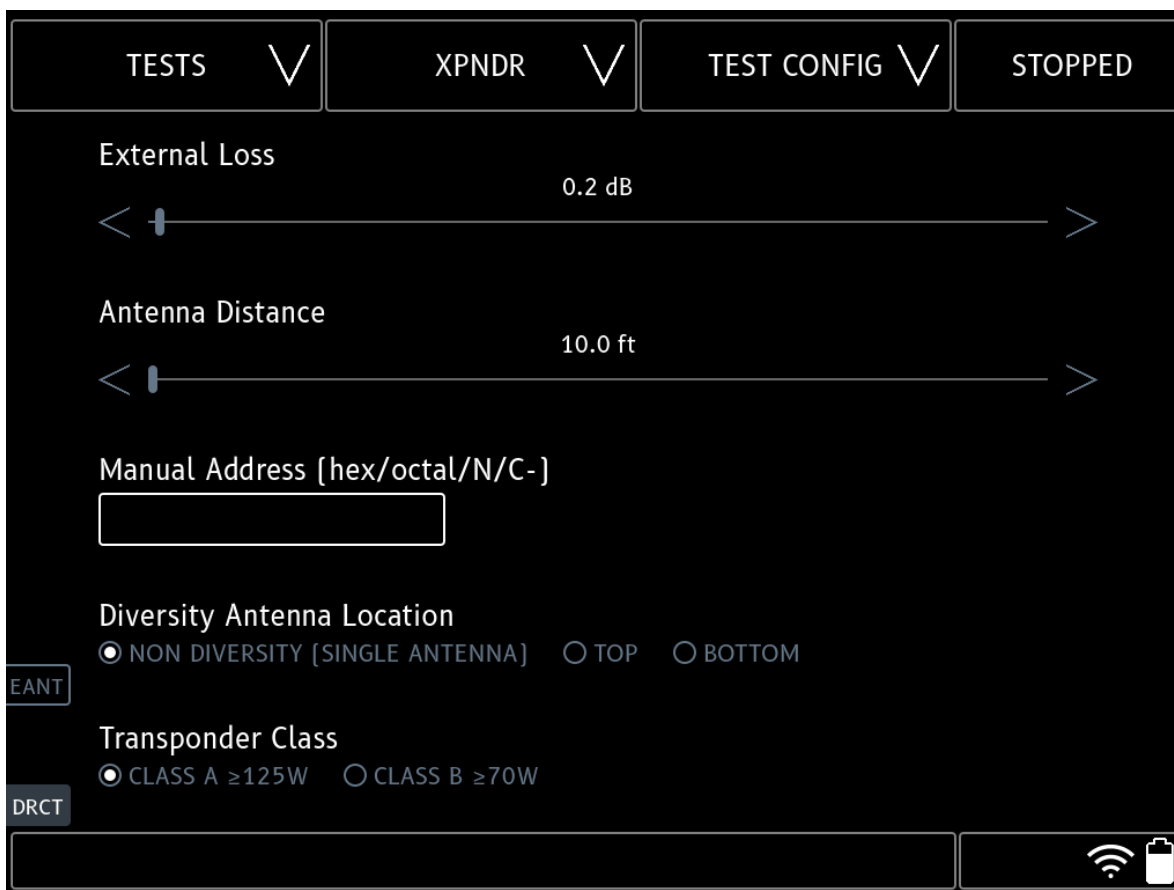

External Loss (dB)	Applies to DRCT or EANT selections only. External loss refers to the loss of the coax connection and optional coupler to a transponder when using the DRCT connection, or of the external antenna when using the EANT selection. Set the external loss by pressing < or >, or manually sliding to the required external loss level. See External Antenna section for more information
Distance (ft)	Applies to EANT or internal antenna selections only. Distance refers to the distance in feet from the transponder antenna under test to the T-RX™ when using the EANT or internal antenna selections. Set the distance by pressing < or >, or manually sliding to the required distance
Manual Address	Restrict Mode-S replies to a Hex address, Octal address, or USA/Canada tail number. Useful when over-the-air tests are performed when multiple powered on aircraft are in the direct vicinity
Diversity Antenna Location	Select from NON-DIVERSITY (Single Antenna), TOP, or Bottom
Transponder Class	Controls minimum power for successful test

Transponder Mode A/C/S Test Item Descriptions

Mode A/S Code	Mode A ATCRBS / Mode S DF5 Squawk code. IDENT and ALERT if active. Appendix F(g) for Mode S
Mode C/S Altitude	Mode C altitude (100 ft resolution) / Mode S DF4 altitude (100 or 25 ft resolution). Appendix F(g) for Mode S
Mode S Address	Mode S DF11 AA ICAO address with Country / registration decoding (decoding USA and Canada only) / Hex / Octal
Flight/Vert Status	FS value / VS value / RI value with RI Max Airspeed decoding / Mode S AIR or GND state
Valid/Invalid Address	✓ If Mode S transponder only replies to its assigned address, otherwise X. Appendix F(f)
Mode S Squitter DF11	✓ If Mode S DF11 correct squitter is present approximately once per second, otherwise X. Appendix F(j)
Mode S UF11 AllCall Reply	✓ If Mode S replies to Mode S only UF11 All Call, otherwise X. Appendix F(h)
Mode S ATCRBS/S AllCall Reply	✓ If Mode S replies to ATCRBS/Mode S All Call, otherwise X. Appendix F(h)
Flight ID	Mode S Flight ID.
Additional Replies	Presence of ADS-B DF17 squitter, and DF16 DF24, DF20, DF21 Mode S replies if capable. Appendix F(g)
Diversity Isolation	✓ If Mode S Diversity Isolation is ≥ 20 dB, otherwise X. Only applicable to a Mode S Diversity transponder and also requires the non-tested antenna to be shielded. The test should be performed on the top and bottom antenna separately. Appendix F(e)
Transmit Frequency	Green if the transponder transmit frequency is 1090 ± 1 for Mode-S replies, ± 3 MHz for ATCRBS only replies, otherwise red (note 1). Appendix F(a)
Mode A/C SLS	✓ If Mode A transponder replies are $\leq 1\%$ when P2 pulse is equal to P1 Pulse, and replies are $\geq 90\%$ when P2 pulse is 9 dB less than P1 pulse, otherwise X. Appendix F(b)

Mode A/C MTL	MTL of Mode A/C transponder. Green if MTL is -66dBm to -80dBm and MTL difference between Mode A and C receiver is not greater than 1dB, otherwise red . Appendix F(c) with an additional 3dB allowance for portable test equipment
Mode S MTL	MTL of Mode S transponder. Green if MTL is -67dBm to -81dBm, otherwise red . Appendix F(c) with an additional 3dB allowance for portable test equipment
Transmit Power	Transmit Peak Power in dBm and Watts. Green if power is ≥ 51 dBm (21 dBW, 125 W) or ≥ 48.5 dBm (18.5 dBW, 70W) and ≤ 57 dBm (27 dBW, 500 W) (note 2). Appendix F(d)
Note 1	Class 1A/2A/3A/4 Mode S transponders have an Appendix F limit of ± 1 MHz. Class 1B/2B/3B/4 Mode S transponders have an optional Appendix F(a) limit of ± 1 MHz. All ATRBS only transponders have an Appendix F limit of ± 3 MHz
Note 2	Select Class A or B in TEST CONFIG menu. Class A transponders have a minimum power of 51 dBm (21 dBW, 125W) , Class B transponders have a minimum power of 48.5 dBm (18.5 dBW, 70 W) in Appendix F(d)

Altitude Monitor Test

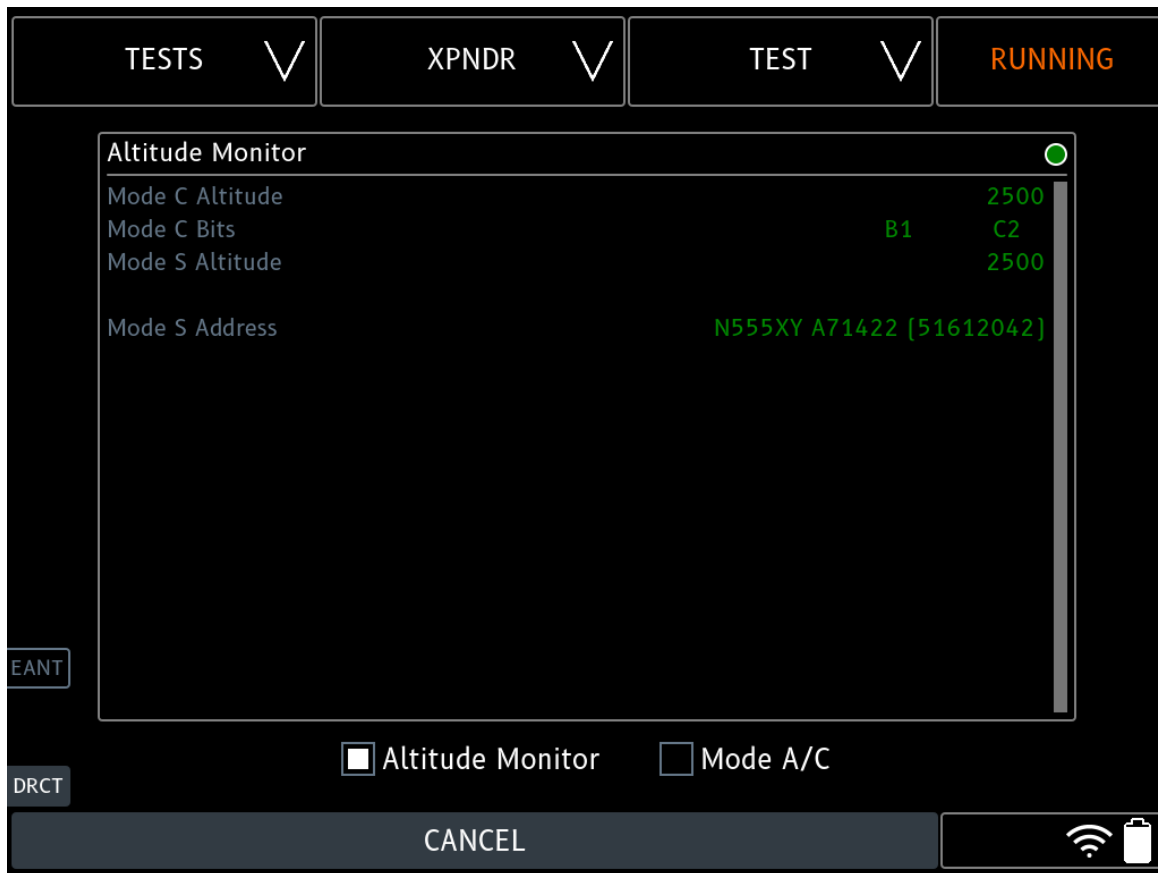

NOTE: Altitude Monitor will only display altitude during a test for a higher update rate. Intended for Altitude Correspondence testing. To enable select the Altitude Monitor box on the XPNDR Test Config page.

ADS-B OUT 1090ES Test

Airborne Mode

TESTS ▾
ADS-B OUT 1090 ▾
TEST ▾
STOPPED

ADS-B 1090ES DF17

Mode S Address	USA N555XY A71422 [51612042]
Flight ID [BDS 0,8 Type 4]	W777
Latitude/Longitude [BDS 0,5 Type 11]	40° 37.529' / -74° 40.044'
Pressure Altitude	-1000 ft
Geometric Altitude	0 ft
Groundspeed [BDS 0,9 Type 19]	W 0 / N 0 kts
Mode A Code	1200
Emergency/Priority Status / State	No Emergency [0] / Airborne
Emitter Category	Light < 15.5K lbs [A1]
TCASII/ACAS Equipped/Operational	No [0]
ADS-B IN	1090ES
NACp	< 10m [10] ✓
NACv	<3 m/s [2] ✓
NIC	9 ✓
SDA	DAL C [2] ✓
SIL/SIL SUP	≤1x10 ⁻⁷ [3]/hour [0] ✓
MOPS Version [BDS 6,5 Type 31]	v2 DO-260B/ED-102A DO-242B ✓

EANT
DRCT

RUN

TIME	Synchronized UTC No [0]
NICbaro	Pressure Altitude Cross-Checked [1]
GVA	≤45m [2]
Vertical Rate	+0 ft/min
Baro Setting [BDS 6,2 Type 29]	29.93 inHg
Selected Altitude [BDS 6,2 Type 29]	2496 ft Src: MCP/FCU
Selected Heading [BDS 6,2 Type 29]	30.2°
MCP/FCU Modes	---
Antenna	Single

EANT
DRCT

CANCEL

Surface Mode

The screenshot shows the 'TESTS' menu with 'ADS-B OUT 1090' selected. The 'TEST' button is active, and the status is 'STOPPED'. The test results for 'ADS-B 1090ES DF17' are displayed in a list:

- Mode S Address: USA N555XY A71422 [51612042]
- Flight ID [BDS 0,8 Type 4]: W777
- Length/Width Upper Bound: 45m/45m [7]
- Latitude/Longitude [BDS 0,6 Type 7]: 40° 37.528' / -74° 40.042'
- Direction/Groundspeed: 101.2° T / ---
- Mode A Code: 1200
- Emergency/Priority Status / State: No Emergency [0] / Surface
- Emitter Category: Light < 15.5K lbs [A1]
- TCASII/ACAS Equipped/Operational: No [0]
- ADS-B IN: 1090ES
- NACp: < 30m [9] ✓
- NACv: <3 m/s [2] ✓
- NIC: 8 ✓
- SDA: DAL C [2] ✓
- SIL/SIL SUP: ≤1x10⁻⁷ [3]/hour [0] ✓
- MOPS Version [BDS 6,5 Type 31]: v2 DO-260B/ED-102A DO-242B ✓
- TIME: Synchronized UTC No [0]

At the bottom, there is a 'RUN' button and a battery icon. A label 'EANT' is visible on the left side of the results area, and 'DRCT' is visible below it.

The screenshot shows the 'GPS Antenna' settings menu. The 'EANT' label is selected, and the settings are:

- GPS Antenna LAT Offset: R 0m
- GPS Antenna LON Offset: 2m
- Antenna: Single

At the bottom, there is a 'RUN' button and a battery icon. A label 'DRCT' is visible on the left side of the settings area.

EANT/DRCT	Select EANT for an external antenna, DRCT for a direct connection, or no selection for the internal antenna
RUN/CANCEL	Selecting RUN will run the test continuously until CANCEL is selected.
NOTE: A Transponder antenna coupler should only be attached to the DIRECT antenna port	

ADS-B OUT 1090 Test Config



<p>Latitude</p>	<p>The latitude where the test is being performed, in whole degrees (Positive latitude is N, negative is S). Latitude does not need to be exact (unless Show Position Difference is selected), it indicates the N or S hemisphere for surface position ambiguity resolution. If the configured Latitude is in the correct hemisphere then the surface position will be decoded correctly</p>
<p>Longitude</p>	<p>The longitude where the test is being performed, in whole degrees (Positive longitude is E, negative is W). Longitude does not need to be exact (unless Show Position Difference is selected), it indicates the E/W quadrants (< 90 E, ≥ 90 E, < 90 W, ≥ 90 W) for Surface Position ambiguity resolution. If the configured Longitude is in the correct quadrant then the surface position will be decoded correctly</p>

Show Position Difference	If selected, the Position Difference field will be shown in the test page. Use exact decimal degrees for latitude and longitude fields
External Loss (dB)	Applies to DRCT or EANT selections only. External loss refers to the loss of the coax connection and optional coupler to a transponder when using the DRCT connection, or of the external antenna and coax when using the EANT selection. Set the external loss by pressing < or >, or manually sliding to the required external loss level
Distance (ft)	Applies to EANT or internal antenna selections only. Distance refers to the distance in feet from the transponder antenna under test to the T-RX™ when using the EANT or internal antenna selections. Set the distance by pressing < or >, or manually sliding to the required distance

ADS-B 978 UAT Test

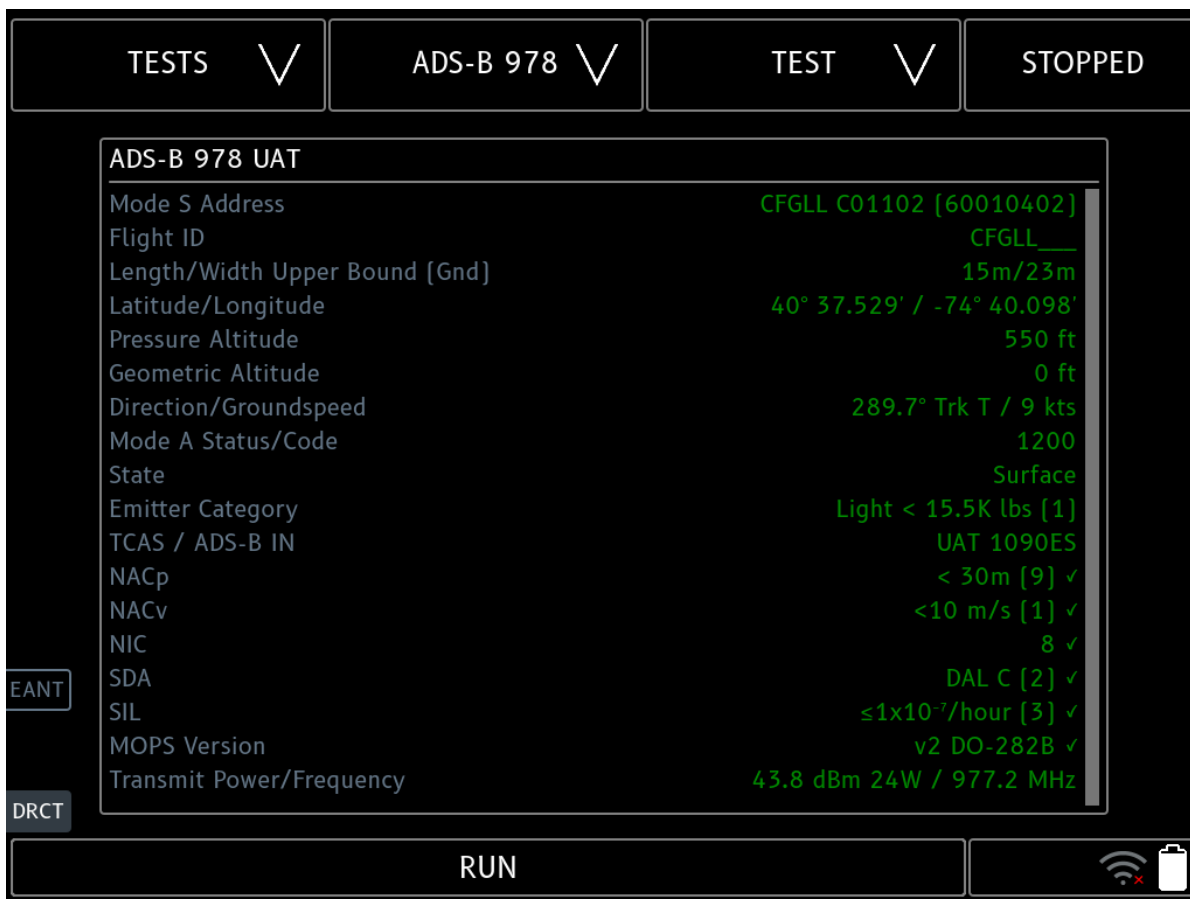

EANT/DRCT	Select EANT for an external antenna, DRCT for a direct connection, or no selection for the internal antenna
RUN/CANCEL	Selecting RUN will run the test continuously until CANCEL is selected. MODE-S will be automatically detected
NOTE: A Transponder antenna coupler should only be attached to the DIRECT antenna port	

ADS-B 978 Test Config



<p>External Loss (dB)</p>	<p>Applies to DRCT or EANT selections only. External loss refers to the loss of the coax connection and optional coupler to a transponder when using the DRCT connection, or of the external antenna and coax when using the EANT selection. Set the external loss by pressing < or >, or manually sliding to the required external loss level</p>
<p>Distance (ft)</p>	<p>Applies to EANT or internal antenna selections only. Distance refers to the distance in feet from the transponder antenna under test to the T-RX™ when using the EANT or internal antenna selections. Set the distance by pressing < or >, or manually sliding to the required distance</p>

ADS-B 1090ES / ADS-B 978 UAT Test Item Descriptions

AC 20-165B required elements shown as error if missing or below requirements

Mode S Address	DF17 ICAO address with country and registration decoding (decoding USA and Canada only) / Hex / Octal
Flight ID	DF17 Flight ID. Error if missing
Length / Width Upper Bound (Gnd)	Reported when in the ground state with raw value. Error if undefined
Latitude / Longitude	Positive latitude is N, negative is S. Positive longitude is E, negative is W. 1090ES Surface (Gnd) position requires current position set in the config page to resolve N-S hemisphere and E-W quadrant ambiguity Note: 1090ES position is decoded using the Global CPR algorithm which fully utilizes all even/odd data sent in the ADS-B messages
Pressure / GNSS Altitude	Type is Pressure or GNSS (HAE) as reported by ADS-B transmitter, or "—" if unavailable. Only reported in Air mode
Geometric Altitude	Reported if altitude type is pressure and GNSS altitude available. Only reported in Air mode
Groundspeed -or- Airspeed	E/W and N/S if GNSS velocity over ground available Airspeed in knots if groundspeed is not available
Heading / Track	Heading/Track Mag/True if groundspeed is not available
Mode A Code	Mode A squawk. IDENT, Emerg Alert, Temp Alert if active. Allowed to be missing if Mode A code is set to 1000
Emergency / Priority Status	Emergency/Priority Status type and code
State	Airborne or Surface
Emitter Category	Category and raw value as programmed in the ADS-B transmitter. Error if missing

TCAS II / ACAS Equipped / Operational	TCAS II or ACAS equipment installed and operational and raw value. It will also report if an RA is in progress
ADS-B IN	UAT and/or 1090ES IN capability reported
NACp	Navigation Accuracy Category - Position Error if below 8
NACv	Navigation Accuracy Category - Velocity Error if 0
NIC	Navigation Integrity Category Error if below 7
SDA	System Design Assurance Error if below 2
SIL/SIL SUP	Source Integrity Level and Supplement with raw values SIL Error if below 3
MOPS Version	MOPS Version number and corresponding RTCA / EUROCAE standards Error if below 2
TIME	ADS-B transmissions synchronized to UTC and raw value
NICbaro	Indicates pressure altitude crosscheck status and raw value
Vertical Rate	Vertical Rate in ft/min
GVA	Geometric Vertical Accuracy and raw value
Baro Setting	Optional baro pressure setting
Selected Altitude	Optional selected altitude
Selected Heading	Optional selected heading
MCP/FCU Modes	Optional Mode Control Panel/Flight Control Unit/FMS modes
Antenna	Single or Dual

ADS-B IN 1090 Test

TESTS ▾
ADS-B IN 1090 ▾
TEST ▾
STOPPED

Target Distance [nm]

Target Altitude [ft]

Target Bearing [deg]

Target Speed [kts]

Target Vert Rate [+ft/min]

Ownship Address [hex/octal]

Target Type
 AIR GROUND

EANT
DRCT

RUN

Target Distance	Initial distance of target from position set in Config page. If Speed is set, target distance will decrease
Target Speed	Speed encoded in target ADS-B transmission
Target Altitude	Initial altitude of target. If Vert Rate is set, target altitude will increase or decrease
Target Bearing	True Bearing of target from position set in Config page
Ownship Address	ICAO Address of the aircraft being tested, in Hex or Octal. This sets the Service Address for TIS-B and ADS-R service (the "Tower" icon)
Target Type	Airborne or Surface target type

ADS-B IN 1090 Test Config

Latitude/Longitude	Lat/Lon in decimal degrees or whole degrees and decimal minutes. Example: 40.5 degrees and 0 minutes is equivalent to 40 degrees and 30 minutes
Target Address	ICAO Address of target
External Loss (dB)	Applies to DRCT or EANT selections only. External loss refers to the loss of the coax connection and optional coupler to a transponder when using the DRCT connection, or of the external antenna and coax when using the EANT selection. Set the external loss by pressing < or >, or manually sliding to the required external loss level
Distance (ft)	Applies to EANT or internal antenna selections only. Distance refers to the distance in feet from the transponder antenna under test to the T-RX™ when using the EANT or internal antenna selections. Set the distance by pressing < or >, or manually sliding to the required distance
Target Type	Class of target
Mode	ADS-B, TIS-B, or ADS-R Target Type

MODE-S GICB Test

TESTS ▾
MODE-S GICB ▾
TEST ▾
RUNNING

ELS/EHS Registers ●

Mode S Address N1234 A061BB [50060673] Level ≥ 2 Datalink Capable

Register 10h Datalink Capability Report [ELS Required]

Continuation Flag: N Overlay: Y Level 5: N Specific Services: Y
TCAS [ELS Required if installed]: N Flight ID [ELS Required]: Y
Squitter: Y Surv ID: Y GICB Changed: Y UELM: None DELM: None
Subnetwork Version: [5] DO-181E / ED-73E Subnetwork Addr: 00

Register 17h Common GICB Capability Reports Available [ELS Required] ✓

Register 05h Extended Squitter Airborne Position ✓

Register 06h Extended Squitter Surface Position ✓

Register 07h Extended Squitter Status ✓

Register 08h Extended Squitter Identification and Category ✓

Register 09h Extended Squitter Airborne Velocity Information ✓

Register 0Ah Extended Squitter Event-Driven Information ✓

Register 20h Aircraft identification [ELS Required] ✓

Register 21h Aircraft registration number ✓

Register 40h Selected vertical intention [EHS Required] ✓

Register 50h Track and turn report [EHS Required] ✓

Register 60h Heading and speed report [EHS Required] ✓

EANT
DRCT
CANCEL

Register 60h Heading and speed report [EHS Required] ✓

Register 20h Aircraft Identification/Flight ID [ELS Required] DCM123__

Register 40h Selected Vertical Intention [EHS Required]

MCP/FCU Selected Altitude 22000 ft

Baro Setting 1013.2 mb 29.92 in/Hg

Register 50h Track and Turn Report [EHS Required]

Roll Angle 0.5° R

True Track Angle -89.6°

Ground Speed 176.0 kts

True Air Speed 156.0 kts

Register 60h Heading and Speed Report [EHS Required]

Magnetic Heading 207.1°

Indicated Air Speed 150.0 kts

EANT
DRCT
CANCEL

EANT/DRCT	Select EANT for an external antenna, DRCT for a direct connection, or no selection for the internal antenna
RUN/CANCEL	Selecting RUN will run the test continuously until CANCEL is selected.
NOTE: A Transponder antenna coupler should only be attached to the DIRECT antenna port	

MODE-S GICB Test Config



Single GICB Register	Select to interrogate any single GICB Register
Register	Enter Hex value of single register to display. If not selected, all standard ELS/EHS registers displayed.
External Loss (dB)	Applies to DRCT or EANT selections only. External loss refers to the loss of the coax connection and optional coupler to a transponder when using the DRCT connection, or of the external antenna and coax when using the EANT selection. Set the external loss by pressing < or >, or manually sliding to the required external loss level
Distance (ft)	Applies to EANT or internal antenna selections only. Distance refers to the distance in feet from the transponder antenna under test to the T-RX™ when using the EANT or internal antenna selections. Set the distance by pressing < or >, or manually sliding to the required distance

ARINC 429 Test

RX Filtered

This page represents a live view of specific decoded labels.

Time	Label	Parameter	Value	SDI	SSM
2021-08-17 10:35:43.848	247	Horizontal Figure of Merit	0.000 NM	0	normal operation
2021-08-17 10:35:43.848	150	Universal Time Constant [...]	6:23:49	0	normal operation
2021-08-17 10:35:43.848	136	Vertical Figure of Merit	3699.000 Feet	0	normal operation
2021-08-17 10:35:43.848	111	GNSS Longitude	-76.237 Deg	0	normal operation
2021-08-17 10:35:43.848	112	GNSS Ground Speed	427.250 Knots	0	normal operation

Label 1 to Label 5	Select a label to view incoming data.
RUN/CANCEL	Pressing RUN will receive the signal continuously until CANCEL is pressed.
< >	Press the arrow keys to view next or previous values.

RX All

This page represents a view of all decoded labels.

Time	Label	Parameter	Value	SDI	SSM
2021-08-16 15:07:18.796	247	Horizontal Figure of Merit	0.000 NM	0	normal operation
2021-08-16 15:07:18.796	174	East/West Velocity	38.000 Knots	0	normal operation
2021-08-16 15:07:18.796	165	Vertical Velocity	-1.000 Feet/Min	0	normal operation
2021-08-16 15:07:18.796	150	Universal Time Constant [...]	6:23:49	0	normal operation
2021-08-16 15:07:18.796	136	Vertical Figure of Merit	3699.000 Feet	0	normal operation
2021-08-16 15:07:18.796	125	Universal Time Coordinate...	623.800 Hr:Min	0	normal operation
2021-08-16 15:07:18.796	121	GNSS Longitude Fine	0.000 Degrees	0	normal operation
2021-08-16 15:07:18.796	112	GNSS Ground Speed	427.250 Knots	0	normal operation
2021-08-16 15:07:18.796	111	GNSS Longitude	-76.237 Deg	0	normal operation
2021-08-16 15:07:18.796	110	GNSS Latitude	44.978 Deg	3	normal operation

Label	Parameter	Value	Encoding
247	Horizontal Figure of Merit	0.000 NM	bnr
Minimum Interval	Maximum Interval	Discrete States	
200.0	200.0		

REFRESH	Press REFRESH and observe that the Main Table has been populated with the most recent decoded data.
< >	Press the arrow keys to view the next or previous pages of the Main Table.
RUN/CANCEL	Pressing RUN will receive the signal continuously until CANCEL is pressed.
MAIN TABLE	The Main Table populates with Time, Label, Parameter, Value, SDI (Source/Destination Identifiers), and SSM (Sign Status Matrix) data according to the ARINC 429 protocol.
SUB TABLE	Select a given row in the Main Table, and the Sub Table will be populated with more information about the selected row.

RX Raw

This page represents a view of the raw ARINC 429 data.

Time	Label	Raw Data
2021-08-16 15:07:18.796	247	610200e5
2021-08-16 15:07:18.796	174	6026003e
2021-08-16 15:07:18.796	165	7ffe0ae
2021-08-16 15:07:18.796	150	632f8816
2021-08-16 15:07:18.796	136	61ce607a
2021-08-16 15:07:18.796	125	188e0aa
2021-08-16 15:07:18.796	121	68ac008a
2021-08-16 15:07:18.796	112	61ab4052
2021-08-16 15:07:18.796	111	79393092
2021-08-16 15:07:18.796	110	63ff8312

Label	SDI	Binary Data Field	Hex Data Field	SSM
247	0	011000010000001000000000	610200	3

REFRESH	Press REFRESH and observe that the Main Table has been populated with the most recent raw data.
< >	Press the arrow keys to view the next or previous pages of the Main Table.
RUN/CANCEL	Pressing RUN will receive the signal continuously until CANCEL is pressed.
MAIN TABLE	The Main Table populates with Time, Label, and Raw Data according to the ARINC 429 configured protocol.
SUB TABLE	Select a given row in the Main Table, and the Sub Table will be populated with the selected row's Label, SDI, Binary Data Field, Hex Data Field, and SSM.

TX AHRS DIR

TESTS ▾
ARINC 429 ▾
TX AHRS DIR ▾
STOPPED

Enabled Label 314 True Heading Deg/180
 SDI 0 1 2 3 SSM FAILURE NO DATA TEST NORMAL

Enabled Label 320 Magnetic Heading Deg/180
 SDI 0 1 2 3 SSM FAILURE NO DATA TEST NORMAL

Enabled Label 324 Pitch Angle Deg/180
 SDI 0 1 2 3 SSM FAILURE NO DATA TEST NORMAL

Enabled Label 325 Roll Angle Deg/180
 SDI 0 1 2 3 SSM FAILURE NO DATA TEST NORMAL

RUN

Enabled	Enable or disable the ARINC 429 label transmission
SDI	Source/Destination Identifier value
SSM	Sign Status Matrix value
RUN/CANCEL	Pressing RUN will transmit the signal continuously until CANCEL is pressed.

TX AHRS ACCEL

TESTS ▾
ARINC 429 ▾
TX ADC/RADALT ▾
STOPPED

Enabled Label 102 Selected Altitude Ft
SDI 0 1 2 3 SSM FAILURE NO DATA TEST NORMAL

Enabled Label 235 Baro Correction ins Hg
SDI 0 1 2 3 SSM NO DATA TEST NORMAL

Enabled Label 203 Pressure Altitude Ft
SDI 0 1 2 3 SSM FAILURE NO DATA TEST NORMAL

Enabled Label 204 Baro Corrected Altitude Ft
SDI 0 1 2 3 SSM FAILURE NO DATA TEST NORMAL

Enabled Label 206 Computed Airspeed Kts
SDI 0 1 2 3 SSM FAILURE NO DATA TEST NORMAL

Enabled Label 164 Radio Height Ft
SDI 0 1 2 3 SSM FAILURE NO DATA TEST NORMAL

RUN

Enabled	Enable or disable the ARINC 429 label transmission
SDI	Source/Destination Identifier value
SSM	Sign Status Matrix value
RUN/CANCEL	Pressing RUN will transmit the signal continuously until CANCEL is pressed.

TX ADC/RADALT

TESTS ▾
ARINC 429 ▾
TX ADC/RADALT ▾
STOPPED

Enabled Label 102 Selected Altitude Ft
SDI 0 1 2 3 SSM FAILURE NO DATA TEST NORMAL

Enabled Label 235 Baro Correction ins Hg
SDI 0 1 2 3 SSM NO DATA TEST NORMAL

Enabled Label 203 Pressure Altitude Ft
SDI 0 1 2 3 SSM FAILURE NO DATA TEST NORMAL

Enabled Label 204 Baro Corrected Altitude Ft
SDI 0 1 2 3 SSM FAILURE NO DATA TEST NORMAL

Enabled Label 206 Computed Airspeed Kts
SDI 0 1 2 3 SSM FAILURE NO DATA TEST NORMAL

Enabled Label 164 Radio Height Ft
SDI 0 1 2 3 SSM FAILURE NO DATA TEST NORMAL

RUN

Enabled	Enable or disable the ARINC 429 label transmission
SDI	Source/Destination Identifier value
SSM	Sign Status Matrix value
RUN/CANCEL	Pressing RUN will transmit the signal continuously until CANCEL is pressed.

Test Config

TESTS ▾
ARINC 429 ▾
TEST CONFIG ▾
STOPPED

RX1 Enabled

RX2 Enabled

TX1 Enabled

RX1 Data Speed [Kbps]

12.5 100

RX2 Data Speed [Kbps]

12.5 100

TX1 Data Speed [Kbps]

12.5 100

RX1 Equipment

00B - Global Positionir ▾

RX2 Equipment

None ▾

TX1 Transmit Rate [ms]

500

CLEAR ALL TABLE

CLEAR RAW TABLE

RX1 or RX2 Enabled	Enable or disable the ARINC 429 receiver.
Data Speed [kHz]	Select 12.5 for the low speed data rate or 100 for the high speed data rate.
Equipment	Select the Equipment ID for decoding the ARINC 429 messages on channel one.
CLEAR ALL TABLE	Press to clear all data in the ALL table.
CLEAR RAW TABLE	Press to clear all data in the RAW table.
TX1 Enabled	Enable or disable the ARINC 429 transmitter.
TX1 Transmit Rate (ms)	Label repetition rate.

GPS Generator

TESTS ▾
GPS GENERATOR ▾
TEST ▾
STOPPED

Latitude °
 - +

Latitude '
 - +

Longitude °
 - +

Longitude '
 - +

Track °
 - +

Groundspeed kts
 - +

Vert Track °
 - +

Altitude MSL ft
 - +

GPS/SBAS Satellites

GPS PRN 2	Azimuth 167.9 Elevation 39.1
GPS PRN 5	Azimuth 98.6 Elevation 17.8
GPS PRN 10	Azimuth 296.0 Elevation 26.9
GPS PRN 13	Azimuth 49.1 Elevation 22.9
GPS PRN 15	Azimuth 50.8 Elevation 52.4
SBAS PRN 135[48] WAAS	Azimuth 241.7 Elevation 20.9
Lat 40.6260° Lon -74.6700° [40° 37.56' -74° 40.20'] / UTC: 2022/11/14 13:59:57	
Gndspeed 0kts / Track 300° / MSL Alt 100ft / GPS Alt [HAE] -11ft	

CANCEL

Latitude°	Starting Latitude in whole or decimal degrees. N is positive, S is negative.
Latitude'	Starting Latitude decimal minutes. Leave at 0 if decimal degrees are used.
Longitude°	Starting Longitude in whole or decimal degrees. E is positive, W is negative. Initial starting value, will not change with speed or track changes.
Longitude'	Starting Longitude decimal minutes. Leave at 0 if decimal degrees are used.
Track°	Track in degrees. Magnetic Track if magnetic variation is configured.
Groundspeed kts	Groundspeed in knots.
Vert Track°	Vertical Track in degrees. Positive climbing, negative descending.
Altitude MSL ft	WGS84 MSL altitude. Converted to GPS HAE.

GPS Test Config

TESTS ▾
GPS GENERATOR ▾
TEST CONFIG ▾
STOPPED

Magnetic Variation °

-12.0
- +

RF Gain dB

0
- +

RF Loss dB

0
- +

SBAS Enable

DOWNLOAD GPS DATA

Magnetic Variation°	Magnetic Variation of configured position. W is negative, E positive. Set to 0 if True Track is required.
RF Gain dB	0 dB gain is nominal. Range +-10 dB.
RF Loss dB	Coax loss for direct connection to a receiver, or combined loss of coax and antenna coupler. (CCX GPS antenna coupler+coax: 12 dB).
SBAS Enable	SBAS Satellite can be enabled or disabled.
Download GPS Data	Select to download current GPS Almanac and Ephemeris. Requires active Ethernet or WiFi connection. Data will be persistent and active connection is not required for GPS Generator use.

GPS/SBAS Satellite Displayed Data

GPS PRN	PRN of generated GPS satellite 1-32 with elevation and azimuth
SBAS PRN	SBAS Satellite PRN, NMEA Number () and system name (WAAS, EGNOS, MSAS. or GAGAN) with elevation and azimuth
Lat / Lon	Latitude/Longitude of generated position in decimal degrees and degrees / decimal minutes
Date/Time	UTC date and time of generated position. Will always be several hours earlier than actual time due to use of downloaded Ephemeris data.
Groundspeed	Groundspeed of generated position. Speed changes integrated at 8 kts/sec.
Track	Track of generated position. Track changes integrated at 180°/min
MSL Altitude	MSL altitude derived from WGS84 model of GPS HAE
HAE Altitude	GPS Height Above Ellipsoid (HAE)

GPS Generator Usage

The GPS Generator is connected to the T-RX™ USB port using the supplied USB Type A to Type B cable. The GPS Generator TNC output port should be connected to a GPS antenna coupler or directly to a GPS receiver. The GPS Generator RF output port is DC blocking and safe to connect to DC bias supplying GPS receivers.

Before use, download the latest Ephemeris and Almanac files by selecting **DOWNLOAD GPS DATA** in the GPS TEST CONFIG page. An internet connection is needed to download the files (active internet connection is not needed for the GPS Test).

The connected cable loss or combined GPS Coupler+Cable Loss should be entered in the GPS TEST CONFIG PAGE in the RF Loss field. RF Gain can be left at 0 for a nominal RF signal level.

Select **RUN** from the GPS TEST page. The generated data will populate the GPS/SBAS Satellites text area.

Once a GPS lock is achieved, other tests may be run (such as ADS-B OUT) simultaneously with GPS Generator. The satellite icon in the lower right of the display will indicate if the test is running.

GPS Generator Notes

Simultaneous use of GPS Generator Test and XPNDR Test is not recommended due to T-RX resources required by both tests.

GPS Generator is not intended or approved for open air transmission. Only intended for a direct connection to a GPS receiver or a GPS antenna coupler

GPS Receiver may take up to 25 minutes to produce a lock with live satellites if almanac is reloaded by GPS receiver.

GPS Generator UTC time will be several hours older than actual UTC due to use of downloaded Ephemeris.

GPS Generator is compatible with any GPS antenna coupler. GPS antenna coupler loss must be entered in GPS TEST CONFIG page.

GPS receivers will not switch from live to generated signals or vice versa without a power cycle. If GPS generator is restarted GPS receiver should be power cycled.

It is important that the GPS antenna coupler does not allow reception of any live GPS satellites while in use. Some gps antenna couplers tested do not have enough isolation to be used out of doors due to spurious reception of live GPS satellites. The CCX Technologies antenna coupler is recommended for maximum isolation.

SBAS system selection will be automatic based on service area of initial position. Starting positions outside of a SBAS service area will automatically deselect the SBAS satellite and use 6 GPS satellites. SBAS may also be manually deselected in the GPS TEST CONFIG page.

Some GPS receivers will report an antenna failure if a direct connection is made from the GPS Generator and the receiver. A Bias-Tee connected load of approximately 200 ohms will simulate an active antenna and prevent failure reporting. An acceptable Bias-Tee and load is InStock Wireless GPS220 splitter and TT0601 termination.



WARNING: Spurious ADS-B targets may be generated if GPS receiver being tested is connected to an ADS-B OUT system and generated GPS position is above ground elevation. Ensure ADS-B OUT systems do not send spurious data over the air by turning off ADS-B OUT system or using an L-Band coupler to block ADS-B data from being broadcast. Alternatively, ensure generated GPS altitude is at ground level for the generated position.

Test Reports

Test Report - Software 1.6.x and later

The screenshot shows a dark-themed interface with a top navigation bar containing four buttons: TESTS, XPNDR, TEST INFO, and STOPPED, each with a downward arrow. Below this are six input fields arranged in two columns. The left column contains: Aircraft (N123XX), Work Order (A0001), and Technician (TZ). The right column contains: Time Zone (US/Eastern), Test Report (2021-09-23 13:27:43), and Recipient Email Address (tech@example.com). At the bottom of the form are two buttons: VIEW REPORT and SEND REPORT. A status bar at the very bottom shows a battery icon and a Wi-Fi signal icon.

Aircraft	Enter aircraft registration or other identifying information
Work Order	Enter the work order number
Technician	Enter the technician's name or initials
Time Zone	Time Zone used in report time stamp
Test Report	Select Report to view or send via email
Email Address	Enter email address of report recipient
View Report	View the selected report on screen
Send Report	Report will be emailed to the recipient. Requires Ethernet or WiFi connection

View Report

TESTS ▾XPNDR ▾TEST INFO ▾STOPPED

− 1 +

+

−

< >



↑ ↓

T-RX TEST REPORT

TEST: XPNDR MODE-A/C/S

Aircraft: N123XX
Work Order: A0001
Technician: TZ
Date: 2021-09-23 13:27:43 GMT-0400 (EDT)

Mode A / S Code	1200 / 1200
Mode C / S Altitude	-1000 / -1000
Mode S Address	N555XY A71422 (51612042)
Flight Status	AIR
Valid/Invalid Address	✓
Mode S Squitter DF11	✓
Mode S UF11 AllCall Reply	✓
Mode S ATCRBS/S AllCall Reply	✓
Flight ID	W777
Additional Replies	ADS-B DF17 Squit DF20 DF21
Diversity Isolation	N/A
Transmit Frequency	1090.0 MHz
Mode A/C SLS	✓
Mode A/C MTL	-71.0 dBm
Mode S MTL	-73.0 dBm
Transmit Power	53.7 dBm 237W

Remote Control and Reports

The T-RX™ may be operated remotely or Test Reports retrieved using a device with a web browser (PC, laptop, tablet, smartphone). The connection to T-RX™ can be made using a WiFi network, Ethernet connection, or using the T-RX™ Access Point connection.

Enter the T-RX™ IP address in a web browser connected to the same local network. See “How do I connect to an Ethernet/WiFi/Access Point” section for instructions on retrieving the IP Address. Note: IP address will be presented in IP/Network format. Do not use the /XX Network portion.

From a device:

1. Launch a web browser
2. Enter the IP address assigned to the T-RX™
3. Login to the portal with the Username: admin and Password: admin
4. Select a Test to run or a Report to view

Note: T-RX™ uses HTTPS browser connections. Without a certificate installed on the connecting device a SSL Certificate warning page will be encountered (see below). Selecting “ignore the upcoming browser warning” and selecting the subsequent browser pages to ignore the privacy warning will allow the login page to be displayed. Alternatively, the CCX local certificate can be installed on the device which will allow connections with no warnings. Select “CCX Technologies Certificate” to download the certificate. Use the device browser instructions for procedures to install the certificate.

SSL Certificate Warning

You are attempting to access a resource through an SSL Tunnel (https) on a Local Network.

Unfortunately it isn't possible to register Local Network Names or IP Addresses with one of the public Certificate Authorities and as a result it isn't possible to use a certificate that is pre-registered with your browser to access this resource.

You can either import the [CCX Technologies Certificate](#) ¹ or continue on and ignore the upcoming browser warning . You can safely instruct your browser to ignore this warning.

The Dashboard page after login will have selections to select a test to run or a report to view (view report interface will be similar to reports in the T-RX™ TEST INFO menu).

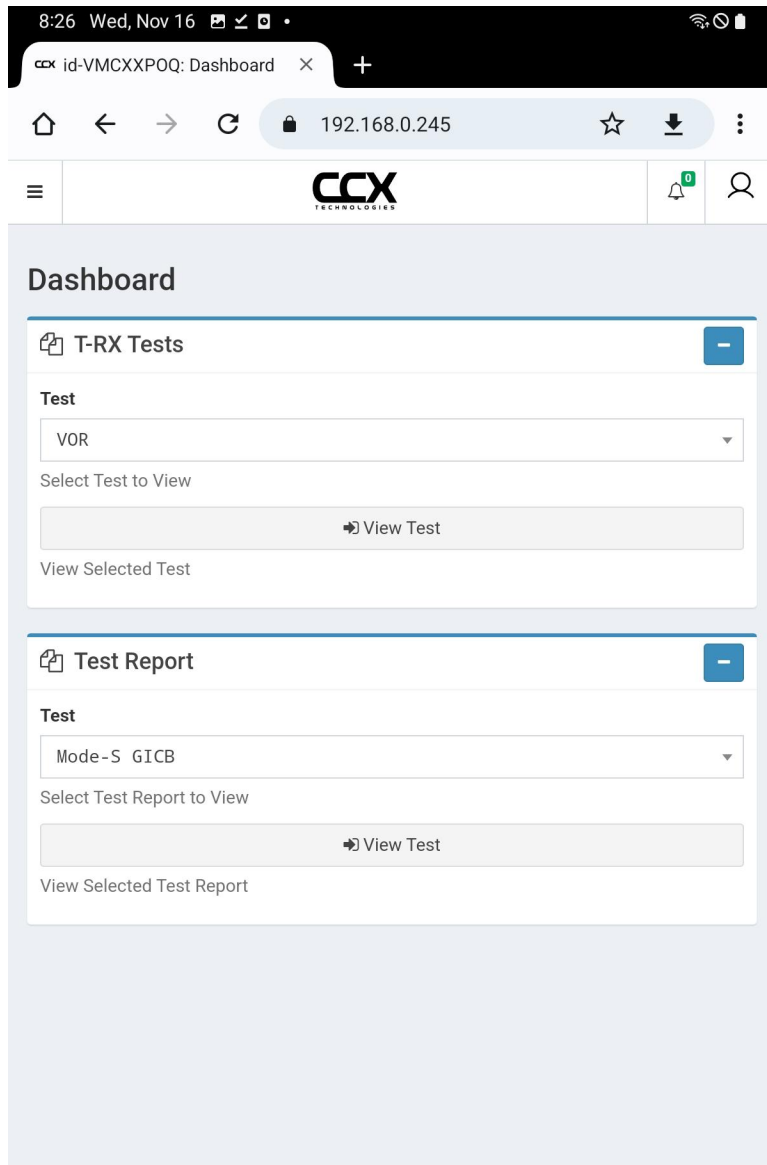

SystemX © CCX Technologies 2017-2021

Select a test to run and "View Test". To run test, make selection changes as needed, select "Run Test", and select "Apply". To stop test uncheck "Run Test" and select "Apply".

The screenshot displays a web browser window with the following details:

- Browser title: id-VMCXXPOQ: VOR
- Address bar: 192.168.0.245/test-vor
- Page title: VOR
- Configuration fields:
 - Frequency (MHz): 108.0
 - RF Level (dBm): -40.0
 - RF Level (uV): 2236.06797749979
 - Bearing (deg.): 90.0
 - Direction: To
 - 1020 Hz Tone:
 - Fail: Normal
 - Frequency Offset (KHz): 0
 - Antenna: Eant
- Status indicators: Run Test and Running
- Action button: Apply

Sample Test Report



T-RX TEST REPORT

TEST: ADSB ADS-B 1090ES

Aircraft: N1234
Work Order: V23432
Technician: Tm
Date: 2019-11-22 14:42:55

Mode S Address	N1234 A061BB (50060673)
Flight ID	DCM123__
Length/Width Upper Bound (Gnd)	45m/45m
Latitude/Longitude	40.6266° / -74.6724°
Altitude	---
Direction/Groundspeed	289.7° T / 10.0 kts
Mode A Code	1200
State	Gnd
Emitter Category	Light < 15.5K lbs
TCASII/ACAS Equipped/Operational	No
ADS-B IN	UAT 1090ES
NACp / NACv	< 10m / <3 m/s
NIC / SDA / SIL	9 / DAL C (2) / $\leq 1 \times 10^{-7}$ /hour (3)
MOPS Version	v2 DO-260B/ED-102A DO-242B

T-RX Hardware Specifications

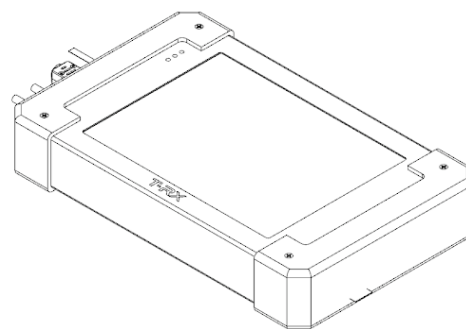
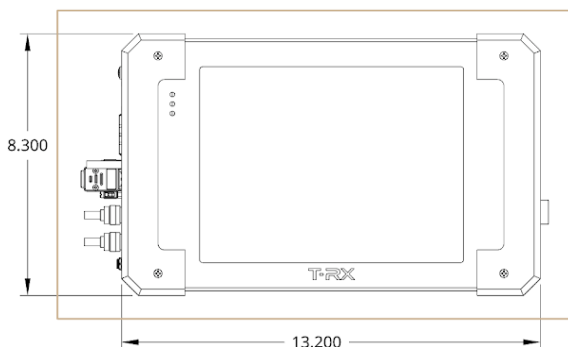

Weight	5.07 lbs (2.3 kg)
Length	13.2 inches (33.5 cm)
Width	8.3 inches (21.1 cm)
Height	2.0 inches (5.1 cm)
Case	Aluminum
Screen Size	10.4 inches (26.4 cm)
Battery Type	Li-ion smart battery
Battery Voltage	≡ 15VDC
Charging Input	≡ 24VDC @ 2.5A
AC Charger	≡ 24VDC Output / 100-240 VAC 50-60 Hz Input
Operating Temp	-20C <-> +50C

T-RX RF Specifications

Frequency Range and Signal Modulation:

- HF Com 5-22 MHz, 1020 Hz USB/AM, 1 KHz spacing
- VHF Com 118.000 - 136.995, 1020 Hz AM, 8.33 KHz spacing (0.005 channels)
- Marker Beacon 75 MHz, AM Outer/Middle/Inner
- VOR 108.00 - 117.95 MHz, 30/9960 Hz AM/FM, 1020 Hz AM, 50 KHz spacing
- Localizer 108.10 - 111.95 90/150 Hz AM, 1020 Hz AM, 50 KHz spacing
- Glideslope 329.15 - 335.00 MHz 90/150 Hz AM, 50 KHz spacing
- UAT ADS-B 978 MHz
- ATCRBS/Mode-S/1090 ADS-B 1030/1090 MHz
- GPS Generator 1575.42 MHz, GPS L1 C/A code and SBAS. RF output DC blocking for direct connection to GPS receivers or antenna couplers

Frequency Stability +/- 1 ppm

VOR/LOC/GS Output level: 0.0 <-> -107.0 dBm +/- 3 dB (Max signal ~-2.0 dBm)

ILS Output level: 0.0 <-> -48.0 dBm (Uncalibrated)

VHF COM Output level: 0.0 <-> -110.0 dBm +/- 3 dB (Max signal ~-2.0 dBm)

HF COM Output level: 0.0 <-> -110.0 dBm +/- 4 dB

(HF COM Max signal ~-2.0 dBm, decreases linearly below 20 MHz)

AM Modulation accuracy: 1%

Marker Modulation accuracy: 1%

VOR AM Modulation accuracy: 1%

VOR FM Modulation accuracy +/- 25 Hz peak deviation

VOR/LOC/GS Tone Frequency accuracy 0.002%

VOR Bearing accuracy +/- 0.1 degree

Localizer DDM accuracy: +/- 0.0015 DDM

Glideslope DDM accuracy: +/- 0.003 DDM

ATCRBS/Mode-S MTL accuracy +/- 2 dB

ATCRBS/Mode-S TX Power accuracy: +/- 2 dB

EANT (External Antenna) port input power: < 0 dBm (1 mW)

DRCT (Direct) port input power: < 44 dBm (25W) CW RF / < 59 dBm (800W) Pulse RF

Regulatory Compliance

T-RX™ fully complies with the following regulatory testing requirements:

Transponder testing: FAR 43 Appendix F / FAR 43 Appendix E(c) (transponder portion) / CAR 571 Appendix F / EASA 2011-15R2

ELT Testing: FAR 91.207(d)(4) / CAR 571 Appendix G

GPS Module Hardware Specifications

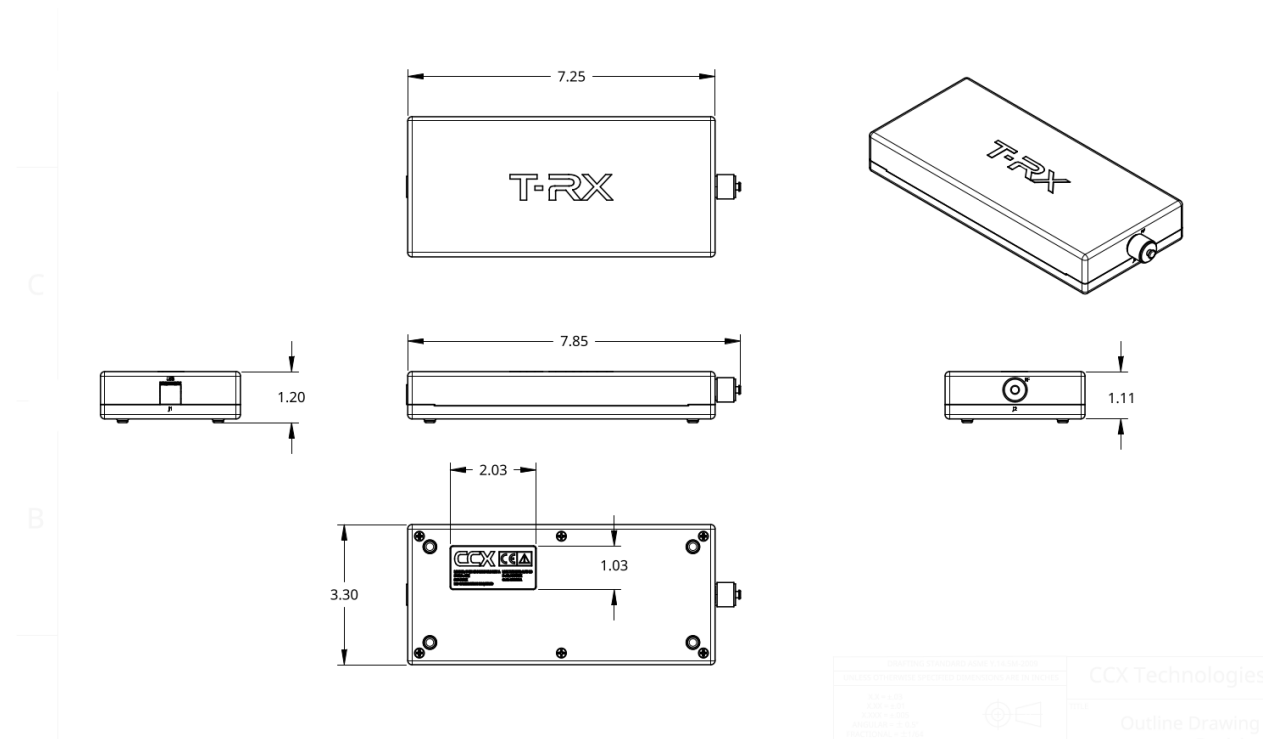

Weight	1.50 lbs (0.68 kg)
Length	7.8 inches (19.81 cm)
Width	3.3 inches (8.38 cm)
Height	1.2 inches (3.05 cm)
Case	Aluminum

GPS Module RF Specifications

GPS Generator Output Level -135 dBm <-> -105 dBm, Loss compensation 0-50 dB

Troubleshooting

Problem: T-RX™ will not power on.

Suggested Action: Does the battery have sufficient charge? Plug-in the provided AC adapter. Try powering your T-RX™. If the unit powers, keep the T-RX™ connected to external power until the battery is fully charged. If the T-RX™ does not stay powered after charging is complete, the battery may need to be replaced.

Problem: The touch screen indicates I am pressing on a different section of the screen other than where I touch.

Suggested Action: Perform a screen calibration per the section above titled, *How to calibrate the T-RX™ touchscreen*.

How do I connect to Remote Support?

Ensure your T-RX is connected to a network with Internet access. Select CONFIGURE/ABOUT/SUPPORT. Select "Enable Remote Support". The circle labelled Remote Support Active automatically turns green if it's connected with CCX TRX Cloud.

Follow these steps for registering with CCX TRX Cloud:

1. Put the T-RX IP address in the browser as a URL to go to the T-RX Web GUI
2. Login to the T-RX Web GUI using credentials:
 - a. user: admin
 - b. password: admin
3. Then navigate to SystemX -> Register with Server -> New Request. Set the Key Manager Server Address to the IP of the server (trx.ccx.cloud) and save it.
4. Click "Submit for Approval".
5. Contact CCX Technologies at trx_support@ccxtechnologies.com to get approval for registering with the server. Once approval is confirmed by a CCX technician, select "Register with Server (requires approval)"
6. A CCX Technologies technician will now be able to assist you by accessing your T-RX remotely.

The screenshot displays the 'Register with Server' interface in the T-RX Web GUI. On the left, a sidebar menu shows 'SystemX' expanded to 'Client-1', with 'New Request' selected. The main content area is divided into three panels:

- Status Panel:** Shows the current status of the request. It includes a 'Submitted for Approval' status (indicated by a red 'x' icon) and an 'Approved' status (indicated by a green checkmark icon). The 'Approved' status is selected, with a sub-message: 'The Key Exchange Request has been approved by the Key Manager Server.' Below this, there are fields for 'Server Name' (id=5MTCWDYY), 'Server Key-Exchange Version' (1.3.0), 'Last Automated Approval Check' (Time of the last automated registration attempt), 'Key Manager Server Public Key' (36db5a7c214b271e87b126055007fe156651ddf75d699d932762529ca62e2267), 'System Part Number Sent' (TER-100), 'System Serial Number Sent' (1078), and 'Site Identification or Tail Number Sent'.
- Configuration Panel:** Contains input fields for 'Request Name' (Client-1), 'Key Manager Server Address' (trx.ccx.cloud), 'Site Identification or Tail Number', 'ICAO Code', 'Contact Name', 'Contact Email', and 'Contact Phone Number'. Each field has a descriptive label and a placeholder.
- Utilities Panel:** Features a 'Submit for Approval' button, a 'Register with Server (requires approval)' button, and a 'Delete' button. A warning message states: 'This system will periodically attempt to register after an access request. This control will force this system to attempt to register immediately.'

License Code Activation Process

A T-RX™ with License Group 'Radio', 'Pulse', or 'Radio Pulse Plus' will not need license activation unless an additional test (such as GPS) is added.

1. Power unit on and wait for unit initialization to complete (~1min)
2. Press the "SETTINGS" menu and select the option "ABOUT"

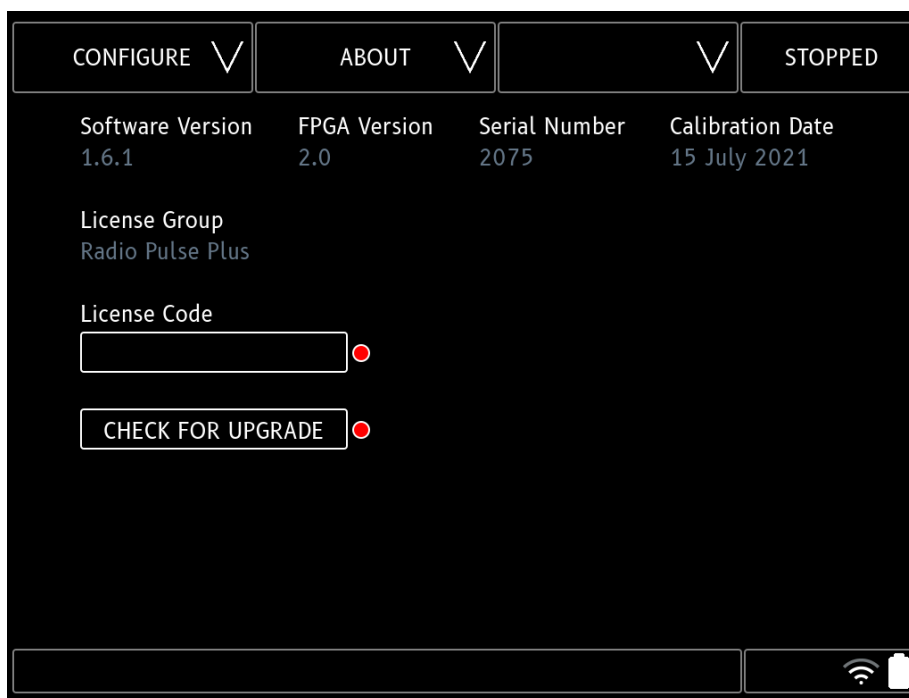

Fig. 1: T-RX "ABOUT" screen

3. Press the "License Code" field box
4. Enter the LICENSE CODE as received from CCX Technologies using the alphanumeric keyboard
5. Press the verify button after the license code has been entered in full
6. If the license code is valid, the license code indicator will change from red to green. If the license code is invalid, the license code indicator will remain red
7. Restart the unit using the power button or software restart and wait for the unit to initialize

8. The desired license will be shown in the License Group.

NOTE: Individual licenses such as GPS will not be shown in the License Group, but will be shown in the Test menu.

FAQ

Q. Will my T-RX™ battery be damaged if the external charger remains connected once the battery has fully charged?

A. No. The Li-ion smart battery will not be damaged. It is safe to leave the charger connected.

Q. Can I upgrade my T-RX™ software in the field?

A. Yes. T-RX™ software upgrades can be performed in the field. Contact CCX Technologies at t-rx_support@ccxtechnologies.com for information on the latest software.

Q. Can I upgrade my T-RX™ Radio or T-RX™ Pulse?

A. Yes! Add-ons can be purchased and added to your T-RX™ in order to support your specific needs.

Q. Is calibration required for my T-RX™?

A. The T-RX™ ships fully calibrated but should be calibrated annually. Contact CCX Technologies to inquire about our annual calibration service.

Contact Us

Should you need any further assistance, contact us either by email or phone.

Refer to your warranty certificate to find the expiry date of the warranty.

Refer to the calibration certificate, the on screen calibration date during boot up, or the About/System page to determine calibration date.

Tech Support: t-rx_support@ccxtechnologies.com

Calibration: calibration@ccxtechnologies.com

Phone: +1 (613) 695-9434